

TECHNICAL DATA SHEET ART. S.4521W - MEGABRIQUE RECTANGULAR

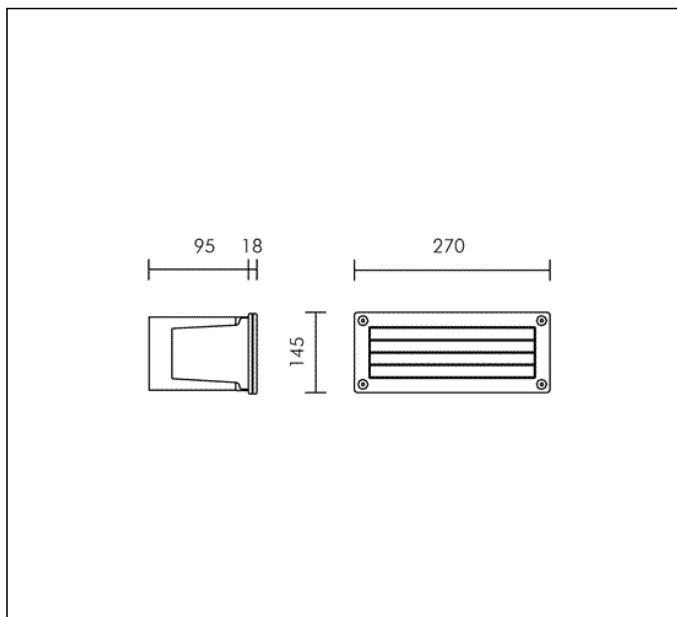

6 MODULES LED 3000K 230V 1140lm 12.6W CRI 90 MacAdam step 3

Rated luminaire luminous flux: 172lm

Rated input power: 17W

Luminaire efficacy: 10lm/W

Electronic ballast 220÷240V 50/60Hz

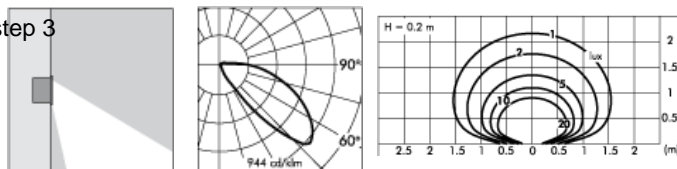

Fixture available with integral DALI driver on request with surcharge.

PRODUCT TYPE

Wall mounted luminaire. IP rating IP 65

MATERIAL CHARACTERISTICS

Aluminium die cast housing in EN AB-47100 (low copper content) and extruded EN AW-6060 with high resistance against corrosion. Stone wash surface treatment prior to painting process. A4 grade Stainless Steel screws with 2,5-3% molybdenum content which increases the resistance against corrosion. EPDM gaskets. Painting Process : 3 Step Process

1) Surface treatment with BONDERITE. A heavy metal free chemical surface treatment containing ceramic nano particles giving a cohesive, inorganic and highly dense protective coating. 2) PRE POLYMERIZATION a process of introducing an epoxy primer with excellent characteristics to the paint which also offers very high resistance to oxidation due to its Zinc content. 3) POLYMERIZATION a process with the application of polyester powder with high resistance against UV rays and harsh weather conditions. Resistance test protection for Marine applications for 1200h. Mechanical resistance IK 06

LIGHTING PERFORMANCE

Reflector in 99.98% pure anodized aluminium . Opal toughened glass diffuser. LOR --

INSTALLATION AND MAINTENANCE

Installation is simple with polypropylene recessing box. Appropriate plastic supports reinforce the centre of the structure. This strategy prevents buckling during the concrete wall construction phase. The luminaires are fixed in the recessing box by stainless steel screws. The reeded glass lightly conceals the view inside the luminaire. The glass is safely protected against blows or vandalism. The trim and the grill hold the glass diffuser in place while covering the rim of the recessing box and the holes. This assures that wall imperfections remain hidden.

WIRING

Double cable entries. Isolation: CLASS I . Available colours: Aluminium grey (cod.14). Weight: 1.9 Kg Glow Wire test: 850°C

Lamp included.

This luminaire contains built-in LED modules with energy class: A, A+, A++. In case of damage or malfunction please contact the manufacturer to receive additional instructions on how to replace and relative spare parts to order. The LED modules cannot be handled in the luminaire by the end user (Regulation UE 874/2012).

LED circuit boards are engineered accordingly to actual Lumen Maintenance regulation (LM80) and Technical Memorandum (TM21) where uniformity and quality of light is 50.000 hours referred to L70 B20 Ta 25°C.

Lifecycle refers to LED circuit boards only, all others components of the luminaire are excluded.

**TECHNICAL DATA SHEET ART. S.4521W - MEGABRIQUE RECTANGULAR
ACCESSORIES**



S.4523
RECESSING BOX RECTANGULAR
263 x 135 mm.
Width 95 mm.