

TECHNICAL DATA SHEET ART. S.4136 - MINICOLUMN 45°

Available until 31/12/2017 but subject to stock levels

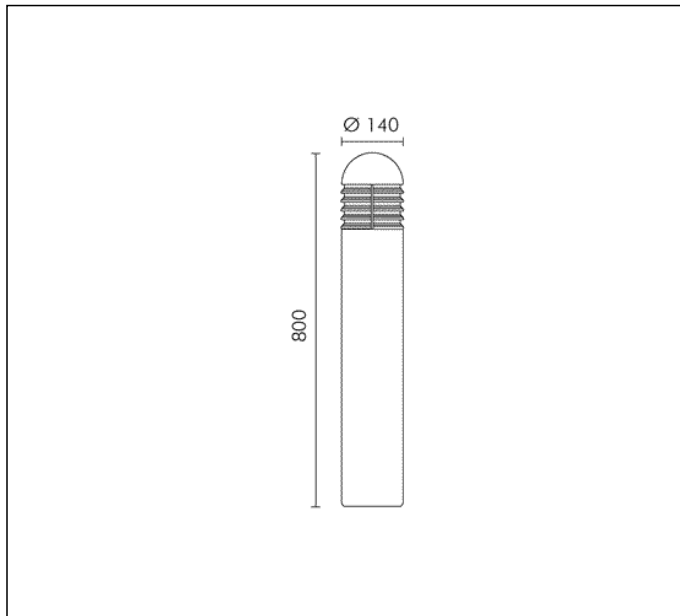

6 MODULES LED 6000K 230V 1070lm 9W CRI 75

Rated luminaire luminous flux: 137lm

Rated input power: 11W

Luminaire efficacy: 12lm/W

Electronic ballast 230÷240V 50Hz

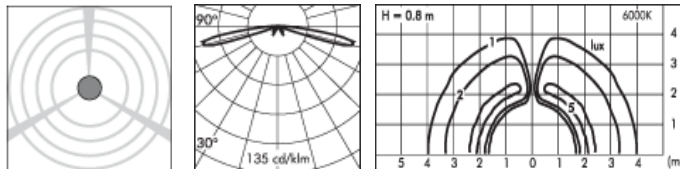

CE □ ◆ ▲ ▲ IP 65 A A+ A++

PRODUCT TYPE

Bollard fitting. IP rating IP 65

MATERIAL CHARACTERISTICS

Extruded EN AW-6060 aluminium profile, die-cast EN AB-47100 aluminium housing with high corrosion resistance. Stone wash surface treatment prior to painting process. A4 grade Stainless Steel screws with 2,5-3% molybdenum content which increases the resistance against corrosion. Pre treated Silicone Gaskets. Painting Process : 3 Step Process

1) Surface treatment with BONDERITE. A heavy metal free chemical surface treatment containing ceramic nano particles giving a cohesive, inorganic and highly dense protective coating. 2) PRE POLYMERIZATION a process of introducing an epoxy primer with excellent characteristics to the paint which also offers very high resistance to oxidation due to its Zinc content. 3) POLYMERIZATION a process with the application of polyester powder with high resistance against UV rays and harsh weather conditions. Resistance test protection for Marine applications for 1200h. Mechanical resistance IK 10

LIGHTING PERFORMANCE

Clear polycarbonate lens with controlled downward light emission for avoiding any glare, UV-stabilised and vandalproof . Lamp fixed position . LOR --

WIRING

Supplied with rubber 0.3m cable H07RN-F and fast connector IP67. The connector must be connected at the supply line (Ø 12÷16 mm). Isolation: CLASS II . Available colours: Aluminium grey (cod.14). Weight: 5.1 Kg Glow Wire test: 750°C

Lamp included.

This luminaire contains built-in LED modules with energy class: A, A+, A++. In case of damage or malfunction please contact the manufacturer to receive additional instructions on how to replace and relative spare parts to order. The LED modules cannot be handled in the luminaire by the end user (Regulation UE 874/2012).

LED circuit boards are engineered accordingly to actual Lumen Maintenance regulation (LM80) and Technical Memorandum (TM21) where uniformity and quality of light is 50.000 hours referred to L70 B20 Ta 25°C.

Lifecycle refers to LED circuit boards only, all others components of the luminaire are excluded.

TECHNICAL DATA SHEET ART. S.4136 - MINICOLUMN 45° INCLUDED ACCESSOIRES



FAST CONNECTOR INCLUDED

ACCESSORIES



S.4172
FLANGE

Flange Ø 140mm h 115mm to be fixed in concrete with stainless steel screws for fixing in the ground. Footstall dimension can be calculated according to your country norms and ground properties.

Further information

FIXING BASE

