

TECHNICAL DATA SHEET ART. S.1227N - MINISTAGE

Version is available on request

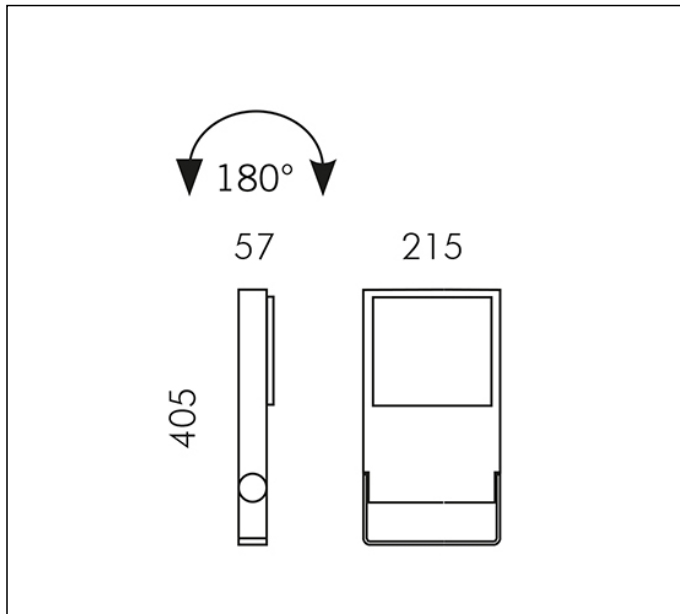

4 MODULES LED COB 4000K 230V 5344lm CRI 80

Rated luminaire luminous flux: 4275lm

Rated input power: 39W

Luminaire efficacy: 110lm/W

Electronic ballast 220÷240V 50/60Hz

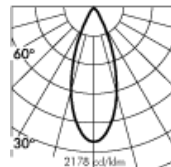
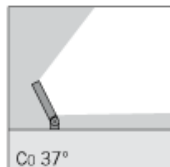

h(m)	37° Ø(m)	3000K E(lx)
2	1.35	2262
4	2.71	565
6	4.06	251
8	5.42	141
10	6.77	90

* Computer-simulated photometrics



Fixture available with integral DALI driver on request with surcharge.

PRODUCT TYPE

Projector. IP rating IP 65

MATERIAL CHARACTERISTICS

Die-cast EN AB-47100 aluminium housing with high corrosion resistance. Stone wash surface treatment prior to painting process. A4 grade Stainless Steel screws with 2,5-3% molybdenum content which increases the resistance against corrosion. Silicone gaskets. Painting Process : 3 Step Process

1) Surface treatment with BONDERITE. A heavy metal free chemical surface treatment containing ceramic nano particles giving a cohesive, inorganic and highly dense protective coating. 2) PRE POLYMERIZATION a process of introducing an epoxy primer with excellent characteristics to the paint which also offers very high resistance to oxidation due to its Zinc content. 3) POLYMERIZATION a process with the application of polyester powder with high resistance against UV rays and harsh weather conditions. Resistance test protection for Marine applications for 1200h. Mechanical resistance IK 06

LIGHTING PERFORMANCE

Reflector in 99.98% pure anodized aluminium HI-GRADE . Clear toughened glass. The scoop optic of the asymmetric version assures a high visual comfort avoiding the direct visibility of the LED source that normally has a high glaring luminance package (Asymmetric version).LOR --

INSTALLATION AND MAINTENANCE

The tempered front glass diffuser is fixed externally to the fitting through silicon resin, perfectly flush with the front ring. Water and dirt deposits that can disturb the lighting performance of the projector can easily flow away.

WIRING

Luminaire suitable for double cable glands. Isolation: CLASS II . Available colours: Aluminium grey (cod.14). Weight: Kg Glow Wire test: --

Lamp included.

REGISTERED DESIGN

This luminaire contains built-in LED modules with energy class: A, A+, A++. In case of damage or malfunction please contact the manufacturer to receive additional instructions on how to replace and relative spare parts to order. The LED modules cannot be handled in the luminaire by the end user (Regulation UE 874/2012).

LED circuit boards are engineered accordingly to actual Lumen Maintenance regulation (LM80) and Technical Memorandum (TM21) where uniformity and quality of light is 50.000 hours referred to L70 B20 Ta 25°C.

Lifecycle refers to LED circuit boards only, all others components of the luminaire are excluded.