

TECHNICAL DATA SHEET ART. S.1071 - FOCUS

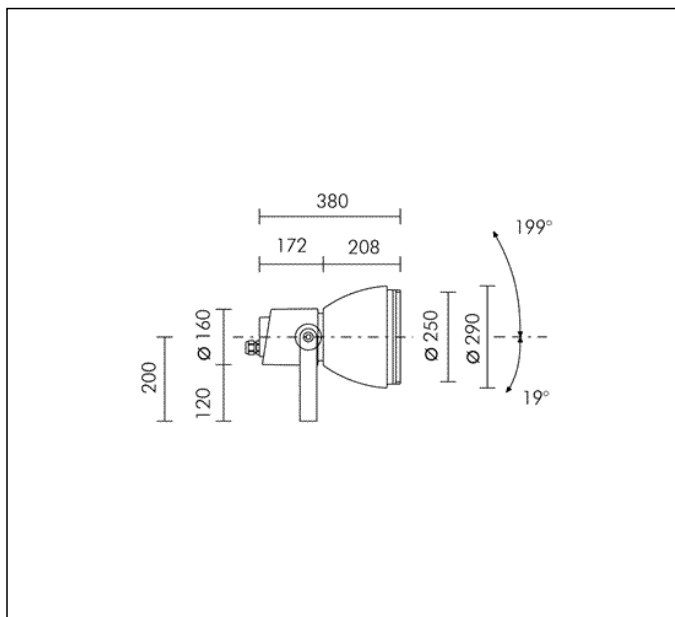

HIT-CRI 70W CLEAR G12 6600lm
 Rated luminaire luminous flux: 3828lm
 Rated input power: 84W
 Luminaire efficacy: 46lm/W (LOR: 58%)
 Magnetic transformer 230÷240V 50Hz
 EEI=A3, LOSSES=12.2W

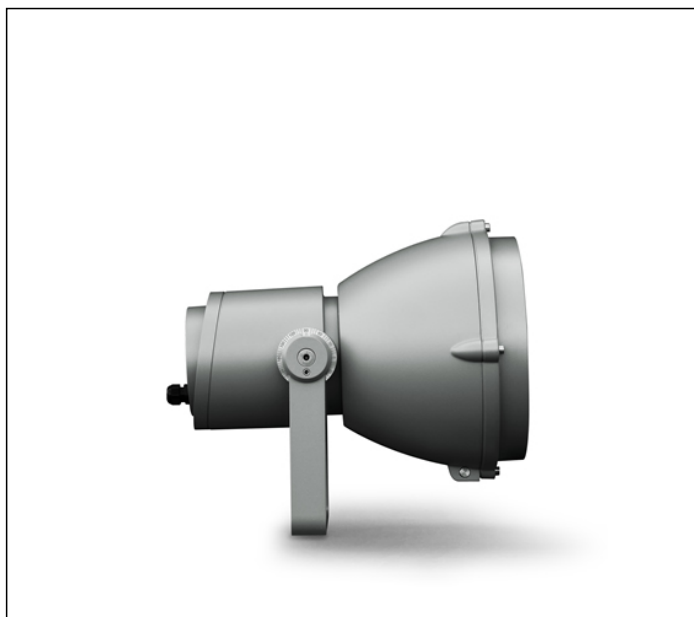
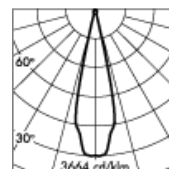
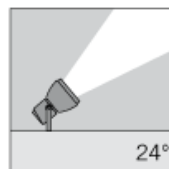

h(m)	Ø(m)	E(lx)
4	1.70	1386
8	3.40	346
12	5.10	154
16	6.80	87
20	8.50	55

CE IP 66

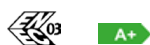

PRODUCT TYPE

Projector. IP rating IP 66

MATERIAL CHARACTERISTICS

Aluminium die cast housing in EN AB-47100 (low copper content) with high resistance against corrosion. Stone wash surface treatment prior to painting process. A4 grade Stainless Steel screws with 2,5-3% molybdenum content which increases the resistance against corrosion. Pre treated Silicone Gaskets. Painting Process : 3 Step Process

1) Surface treatment with BONDERITE. A heavy metal free chemical surface treatment containing ceramic nano particles giving a cohesive, inorganic and highly dense protective coating. 2) PRE POLYMERIZATION a process of introducing an epoxy primer with excellent characteristics to the paint which also offers very high resistance to oxidation due to its Zinc content. 3) POLYMERIZATION a process with the application of polyester powder with high resistance against UV rays and harsh weather conditions. Resistance test protection for Marine applications for 1200h. The 8 mm thick tempered glass diffuser is fixed to the external body by a silicon resin and positioned flush with the support ring. Mechanical resistance IK 10 Maximum load capacity --

LIGHTING PERFORMANCE

The lathed anodized reflector is composed of 99,98% pure anodized aluminium with a bright polish finish. LOR 58%

INSTALLATION AND MAINTENANCE

The projector is supplied with graduated ferrules in AISI 316L stainless steel on both sides of the fitting. The screws that fix the front glass holder to the main body of the projector are also in AISI 316L stainless steel with anti loss washers. The glass diffuser and front support ring are secured to the body of the projector by a pivoting hinge assembly that when opened allows for easy access to the lamp and the reflector. All the internal accessories such as lenses, coloured filters and antiglare shield are fixed to the pivoting front support ring and allow for easy access to the lamp and reflector.

WIRING

Double cable entries with PG16 (Ø 10÷14 mm) cable glands in nicked brass. Isolation: CLASS I. Available colours: Aluminium grey (cod.14). Weight: 10 Kg Glow Wire test: 960°C

Lamp not included.

FOCUS/MEGAFOCUS REGISTERED DESIGN

This luminaire is compatible with bulbs of the energy classes: A+ (Regulation UE 874/2012).

TECHNICAL DATA SHEET ART. S.1071 - FOCUS ACCESSORIES



**S.1032
VISOR**
Colour: black (code 09).

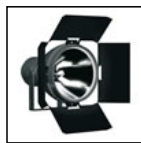

**S.1033
ADJUSTABLE BARN DOORS**
Every box S.1033 contains only one flap. To receive the complete system of 4 flaps you have to order n°4 S.1033. Colour: black (code 09).



**S.1031
WIDE LENS**
To install inside the fitting.
One lens and one coloured filter can be used together. They must be fixed inside the luminaire.



**S.1035
ANTIGLARE SHIELD**
For wide beams 24°/26°. To install inside the fitting.

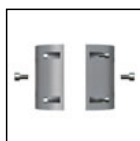

**S.1013
FLANGE FOR POLE INSTALLATION Ø 120mm**
Flange in die-cast aluminium suitable only for Ø 120 mm poles. The flange can be used for maximum 2 projectors, one for each side.

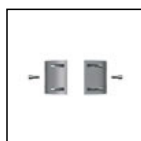

**S.1016
FLANGE FOR POLE Ø 60mm INSTALLATION**
Die-cast aluminium flange suitable only for Ø 60 mm poles. To install the flange on Ø 76mm pole the screws kit SACVITFOCTOWER2 must be purchased separately. The flange can be used for maximum 2 projectors, one for each side.
Product is suitable for installation on SIMES poles Ø 60mm Art.S.2842-S.2843 and Ø 76mm S.2844-S.2845

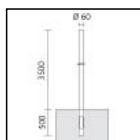

**S.2842
Ø60mm CYLINDRICAL POLE TO BE BURIED**
Cylindrical shaped poles consisting of: straight circular section shaft, Ø 60mm, 4mm in thickness, total length 4,00m, single section built by using longitudinally welded tubes by induction welding (ERW) UNI EN 10219-2-ISO 4200

Suitable for ground recessed installation to a cement base 0,50m : Suggested reinforced concrete footstall dimension 0,7m x 0,7m h 0,7m. Footstall dimension can be calculated according to your country norms and ground properties.

The grade of steel used is S235JR (Fe360B) with material characteristics as per normative UNI EN 10025; The surface protection treatment is done through hot dip galvanization.

Painting Process: PRE POLYMERIZATION a process of introducing an epoxy primer with excellent characteristics to the paint which also offers very high resistance to oxidation due to its Zinc content. POLYMERIZATION a process with the application of polyester powder with high resistance against UV rays and harsh weather conditions. Resistance test protection for Marine applications for 1500h.

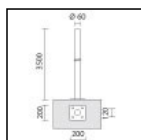

**S.2843
Ø60mm CYLINDRICAL POLE WITH BASE**
Cylindrical shaped poles consisting of: straight circular section shaft, Ø 60mm, 4mm in thickness, total length 3,50m, single section built by using longitudinally welded tubes by induction welding (ERW) UNI EN 10219-2-ISO 4200

Suitable for installation to a planted root flange through a base plate in steel S355JO Footstall dimension can be calculated according to your country norms and ground properties.

The grade of steel used is S235JR (Fe360B) with material characteristics as per normative UNI EN 10025; The surface protection treatment is done through hot dip galvanization.

Painting Process: PRE POLYMERIZATION a process of introducing an epoxy primer with excellent characteristics to the paint which also offers very high resistance to oxidation due to its Zinc content. POLYMERIZATION a process with the application of polyester powder with high resistance against UV rays and harsh weather conditions. Resistance test protection for Marine applications for 1500h.

TO BE USED WITH THE FOLLOWING ACCESSORIES:
S.2849 PLANTED ROOT for CYLINDRICAL POLE

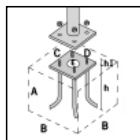

**S.2849
PLANTED ROOT for CYLINDRICAL POLE**
C= 200mm, D=200mm E=Ø80mm, h=407mm, h1=90mm and bolts in galvanized steel with M16 threads. Suggested reinforced concrete footstall dimension **: A = 0.7 m B = 0.7 m

**Footstall dimension can be calculated according to your country norms and ground properties.

TO BE USED WITH THE FOLLOWING ACCESSORIES:
S.2800, S.2801, S.2812, S.2813, S.2843, S.2845
CYLINDRICAL POLE



**S.2809
POLE BASE COVER**
For pole with base and pole to be buried Ø102mm or Ø120mm. Die-cast aluminium housing.

TECHNICAL DATA SHEET ART. S.1071 - FOCUS ACCESSORIES

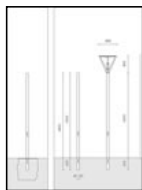

S.2826

Ø 120mm CYLINDRICAL POLE TO BE BURIED

Cylindrical shaped poles consisting of: straight circular section shaft, Ø 120mm, 3mm in thickness, total length 4,80m , single section built by using longitudinally welded tubes by induction welding (ERW) UNI EN 10219-2-ISO 4200

Suitable for ground recessed installation to a cement base 0,60m : Suggested reinforced concrete footstall dimension 0,8m x 0,8m h 0,8m. Footstall dimension can be calculated according to your country norms and ground properties.

The grade of steel used is S235JR (Fe360B) with material characteristics as per normative UNI EN 10025; The surface protection treatment is done through hot dip galvanization.

Painting Process: PRE POLYMERIZATION a process of introducing an epoxy primer with excellent characteristics to the paint which also offers very high resistance to oxidation due to its Zinc content. POLYMERIZATION a process with the application of polyester powder with high resistance against UV rays and harsh weather conditions. Resistance test protection for Marine applications for 1500h.

Including inspection door, terminal cable block and fuse.

Cap COPE2826PVC.09 already installed.

TO BE USED WITH THE FOLLOWING ACCESSORIES:

S.2809 POLE BASE COVER

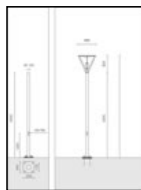

S.2846

Ø 120mm CYLINDRICAL POLE WITH BASE

Cylindrical shaped poles consisting of: straight circular section shaft, Ø 120mm, 3mm in thickness, total length 4,20m , single section built by using longitudinally welded tubes by induction welding (ERW) UNI EN 10219-2-ISO 4200

Suitable for installation to a planted root flange through a base plate 250mm x250mm x12mm in steel S355JO : Suggested reinforced concrete footstall dimension 1m x 1m h 0,7m. Footstall dimension can be calculated according to your country norms and ground properties.

The grade of steel used is S235JR (Fe360B) with material characteristics as per normative UNI EN 10025; The surface protection treatment is done through hot dip galvanization.

Painting Process: PRE POLYMERIZATION a process of introducing an epoxy primer with excellent characteristics to the paint which also offers very high resistance to oxidation due to its Zinc content. POLYMERIZATION a process with the application of polyester powder with high resistance against UV rays and harsh weather conditions. Resistance test protection for Marine applications for 1500h.

Including inspection door, terminal cable block and fuse.

Cap COPE2826PVC.09 already installed.

TO BE USED WITH THE FOLLOWING ACCESSORIES:

S.2840 PLANTED ROOT for CYLINDRICAL POLE

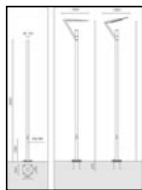

S.2848

Ø 120mm CYLINDRICAL POLE WITH BASE

Cylindrical shaped poles consisting of: straight circular section shaft, Ø 120mm, 3mm in thickness, total length 6,00m , single section built by using longitudinally welded tubes by induction welding (ERW) UNI EN 10219-2-ISO 4200

Suitable for installation to a planted root flange through a base plate 250x250x12mm in steel S355JO : Suggested reinforced concrete footstall dimension 1x1 h 0,7m. Footstall dimension can be calculated according to your country norms and ground properties.

The grade of steel used is S235JR (Fe360B) with material characteristics as per normative UNI EN 10025; The surface protection treatment is done through hot dip galvanization.

Painting Process: PRE POLYMERIZATION a process of introducing an epoxy primer with excellent characteristics to the paint which also offers very high resistance to oxidation due to its Zinc content. POLYMERIZATION a process with the application of polyester powder with high resistance against UV rays and harsh weather conditions. Resistance test protection for Marine applications for 1500h.

MINISLOT AVANT-GARDE INSTALLED ON S.2848 POLE:

Finished product total height = 7.13 m

Cap COPE2826PVC.09 already installed.

TO BE USED WITH THE FOLLOWING ACCESSORIES:

S.2840 PLANTED ROOT for CYLINDRICAL POLE

S.2809 POLE BASE COVER

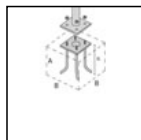

S.2840

PLANTED ROOT for CYLINDRICAL POLE

h = 470 mm and bolts in galvanized steel with M16 threads. Suggested reinforced concrete footstall dimension:

A = 0.7 m

B = 1 m

Footstall dimension can be calculated according to your country norms and ground properties.

Footstall dimension can be calculated according to your country norms and ground properties.

TO BE USED WITH THE FOLLOWING ACCESSORIES:

S.2846, S.2848 CYLINDRICAL POLE

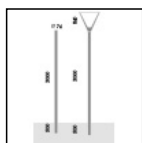

S.2812

Ø 76 mm CYLINDRICAL POLE TO BE BURIED

Cylindrical shaped poles consisting of: straight circular section shaft, Ø 76mm, 3mm in thickness, total length 3,50m, single section built by using longitudinally welded tubes by induction welding (ERW) UNI EN 10219-2-ISO 4200

Suitable for ground recessed installation to a cement base 0,50m: Suggested reinforced concrete footstall dimension 1m x1m h 0,7m. Footstall dimension can be calculated according to your country norms and ground properties.

The grade of steel used is S235JR (Fe360B) with material characteristics as per normative UNI EN 10025;

Painting Process: PRE POLYMERIZATION a process of introducing an epoxy primer with excellent characteristics to the paint which also offers very high resistance to oxidation due to its Zinc content. POLYMERIZATION a process with the application of polyester powder with high resistance against UV rays and harsh weather conditions. Resistance test protection for Marine applications for 1500h.
Including inspection door, terminal cable block and fuse.

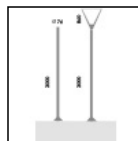
**S.2813****Ø 76mm CYLINDRICAL POLE WITH BASE**

Cylindrical shaped poles consisting of: straight circular section shaft, Ø 76mm, 3mm in thickness, total length 3,00m , single section built by using longitudinally welded tubes by induction welding (ERW) UNI EN 10219-2-ISO 4200

Suitable for installation to a planted roof flange through a base plate 250mm x250mm x12mm in steel S355JO : Suggested reinforced concrete footstall dimension 1m x 1m h 0,7m. Footstall dimension can be calculated according to your country norms and ground properties. The grade of steel used is S235JR (Fe360B) with material characteristics as per normative UNI EN 10025;

The surface protection treatment is done through hot dip galvanization.

Painting Process: PRE POLYMERIZATION a process of introducing an epoxy primer with excellent characteristics to the paint which also offers very high resistance to oxidation due to its Zinc content. POLYMERIZATION a process with the application of polyester powder with high resistance against UV rays and harsh weather conditions. Resistance test protection for Marine applications for 1500h.

Including inspection door, terminal cable block and fuse.
TO BE USED WITH THE FOLLOWING ACCESSORIES:
S.2849 PLANTED ROOT for CYLINDRICAL POLE

Further information

FIXING BASE

