

## SOLID PURE TRACK DALI VERSION

<b>Number of heads</b>	1
<b>Design awards</b>	Red Dot Design Award Winner 2013
<b>Mounting</b>	Three phase track
<b>Lamps description</b>	LED Array 35W 3509 lm 3000K CRI 90
<b>Luminaire luminous flux</b>	See reference number
<b>Voltage (V)</b>	220/240
<b>Environment</b>	Indoor

### OPTICAL

<b>Light controller description</b>	Protection glass
<b>Aiming</b>	Adjustable
<b>Light distribution symmetry</b>	Symmetric
<b>Beam angle</b>	23° Medium

### ELECTRICAL

<b>Transformer availability</b>	Included
<b>Transformer mounting</b>	Integral
<b>Transformer type</b>	Electronic dimmable dali
<b>Emergency</b>	Without
<b>Insulation class</b>	Class I

### PHYSICAL

<b>Diameter (mm)</b>	S/N
<b>Height (mm)</b>	239,5
<b>Spot diameter (mm)</b>	103
<b>Construction material</b>	Aluminium
<b>Weight (kg)</b>	1,70

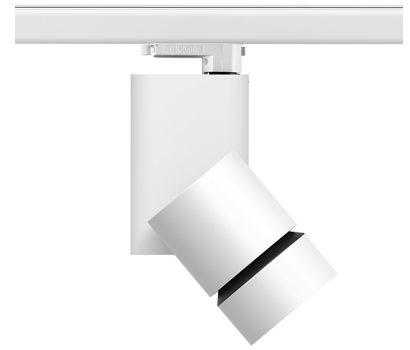

**Solid Pure Track Dali Version**  
designed by Knud Holscher

Spotlight to be installed on 3-circuit-track with LED light source. Integrated power supply 220-240V / 50-60Hz.

- 09.2992.30.DA - 2813lm White
- 09.2992.14.DA - 2813lm Black

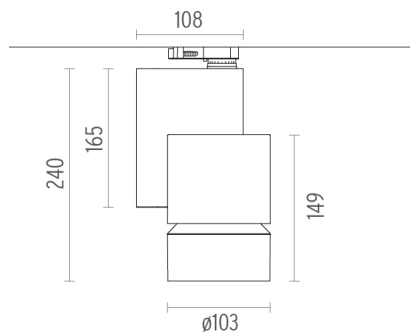

### CERTIFICATIONS

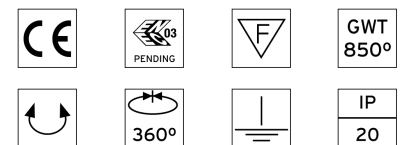

## Solid Pure Track Dali Version . Accessories

### Optical



08.8768.14

#### Holding ring

Holding ring



08.8763.14

#### Honeycomb anti-glare screen

"Honeycomb" anti-glare screen: in thin, black-painted aluminium sheets.



08.8766.64.OD

#### Blue filter

Blue filter



08.8766.65.OD

#### Sky blue filter

Sky blue filter



08.8766.66.OD

#### Amber filter

Amber filter



08.8766.67.OD

#### Red filter

Red filter



#### Solid Pure Track Dali Version designed by Knud Holscher

Spotlight to be installed on 3-circuit-track with LED light source. Integrated power supply 220-240V / 50-60Hz.

09.2992.30.DA - 2813lm White

09.2992.14.DA - 2813lm Black

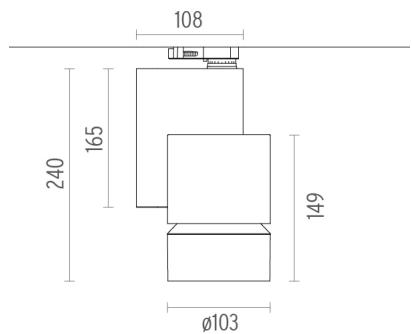

#### CERTIFICATIONS



## Solid Pure Track Dali Version . Lamps



**LED Array**

**Lamp category:**

LED

**Socket:**

Special base

**Lamp type:**

LED Array



**Solid Pure Track Dali Version**  
designed by Knud Holscher

Spotlight to be installed on 3-circuit-track with LED light source.  
Integrated power supply 220-240V / 50-60Hz.

- 09.2992.30.DA - 2813lm White
- 09.2992.14.DA - 2813lm Black

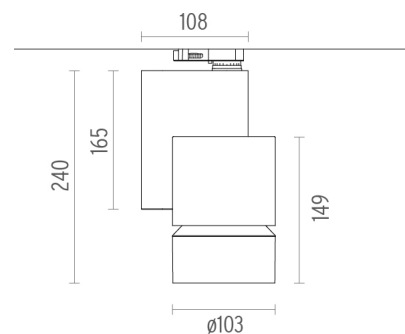

**CERTIFICATIONS**

