

SOLID PURE CEILING/WALL NO DIMMABLE

Number of heads	1
Design awards	Red Dot Design Award Winner 2013
Mounting	Ceiling surface, Wall surface
Lamps description	LED Array 35W 4321 lm 3000K CRI 80
Luminaire luminous flux	See reference number
Voltage (V)	220/240
Environment	Indoor



OPTICAL

Light controller description	Protection glass
Aiming	Adjustable
Light distribution symmetry	Symmetric
Beam angle	15° Spot

Solid Pure Ceiling/Wall No Dimmable
designed by Knud Holscher

Spotlight to be installed on ceiling/wall with LED light source. Integrated power supply 220-240V / 50-60Hz.

ELECTRICAL

Transformer availability	Included
Transformer mounting	Integral
Transformer type	Electronic
Emergency	Without
Insulation class	Class I

● 09.2956.30 - 3473lm	White
● 09.2956.14 - 3473lm	Black

PHYSICAL

Diameter (mm)	S/N
Height (mm)	239,5
Spot diameter (mm)	103
Construction material	Aluminium
Weight (kg)	1,90

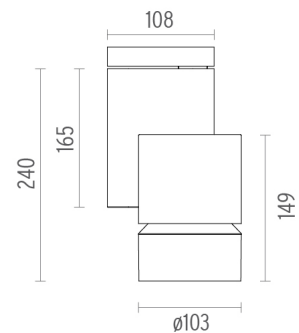

CERTIFICATIONS

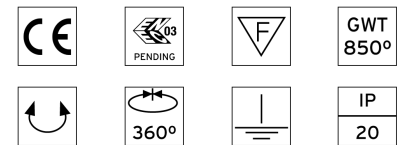

Solid Pure Ceiling/Wall No Dimmable . Accessories

Optical



08.8768.14

Holding ring

Holding ring



08.8763.14

Honeycomb anti-glare screen

"Honeycomb" anti-glare screen: in thin, black-painted aluminium sheets.

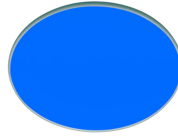

08.8766.64.OD

Blue filter

Blue filter

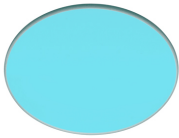

08.8766.65.OD

Sky blue filter

Sky blue filter

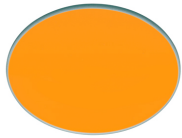

08.8766.66.OD

Amber filter

Amber filter

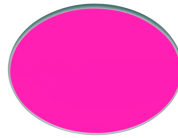

08.8766.67.OD

Red filter

Red filter



Solid Pure Ceiling/Wall No Dimmable
designed by Knud Holscher

Spotlight to be installed on ceiling/wall with LED light source. Integrated power supply 220-240V / 50-60Hz.

- 09.2956.30 - 3473lm White
- 09.2956.14 - 3473lm Black

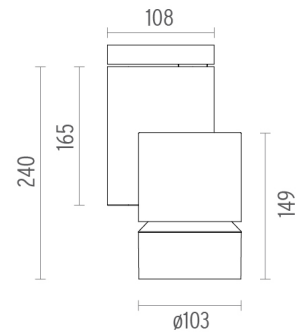

CERTIFICATIONS



Solid Pure Ceiling/Wall No Dimmable . Lamps



LED Array

Lamp category:

LED

Socket:

Special base

Lamp type:

LED Array



Solid Pure Ceiling/Wall No Dimmable
designed by Knud Holscher

Spotlight to be installed on ceiling/wall with LED light source. Integrated power supply 220-240V / 50-60Hz.

- 09.2956.30 - 3473lm White
- 09.2956.14 - 3473lm Black

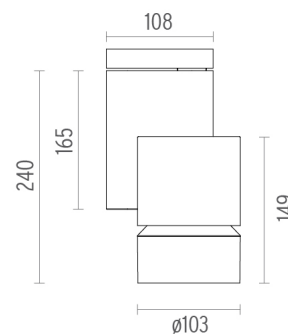

CERTIFICATIONS

