

SOLID PURE TRACK DALI VERSION

Number of heads	1
Design awards	Red Dot Design Award Winner 2013
Mounting	Three phase track
Lamps description	LED Array 30W 3667 lm 4000K CRI 80
Luminaire luminous flux	See reference number
Voltage (V)	220/240
Environment	Indoor

OPTICAL

Light controller description	Protection glass
Aiming	Adjustable
Light distribution symmetry	Symmetric
Beam angle	22° Medium

ELECTRICAL

Transformer availability	Included
Transformer mounting	Integral
Transformer type	Electronic dimmable dali
Emergency	Without
Insulation class	Class I

PHYSICAL

Diameter (mm)	S/N
Height (mm)	239,5
Spot diameter (mm)	103
Construction material	Aluminium
Weight (kg)	1,70

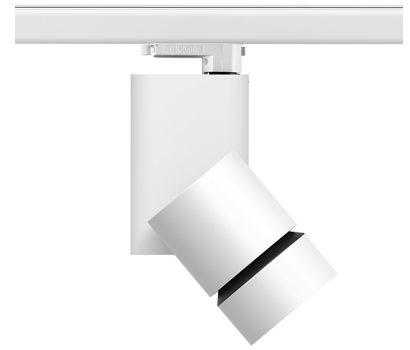

Solid Pure Track Dali Version
designed by Knud Holscher

Spotlight to be installed on 3-circuit-track with LED light source. Integrated power supply 220-240V / 50-60Hz.

- 09.2880.30.DA - 3200lm White
- 09.2880.14.DA - 3200lm Black

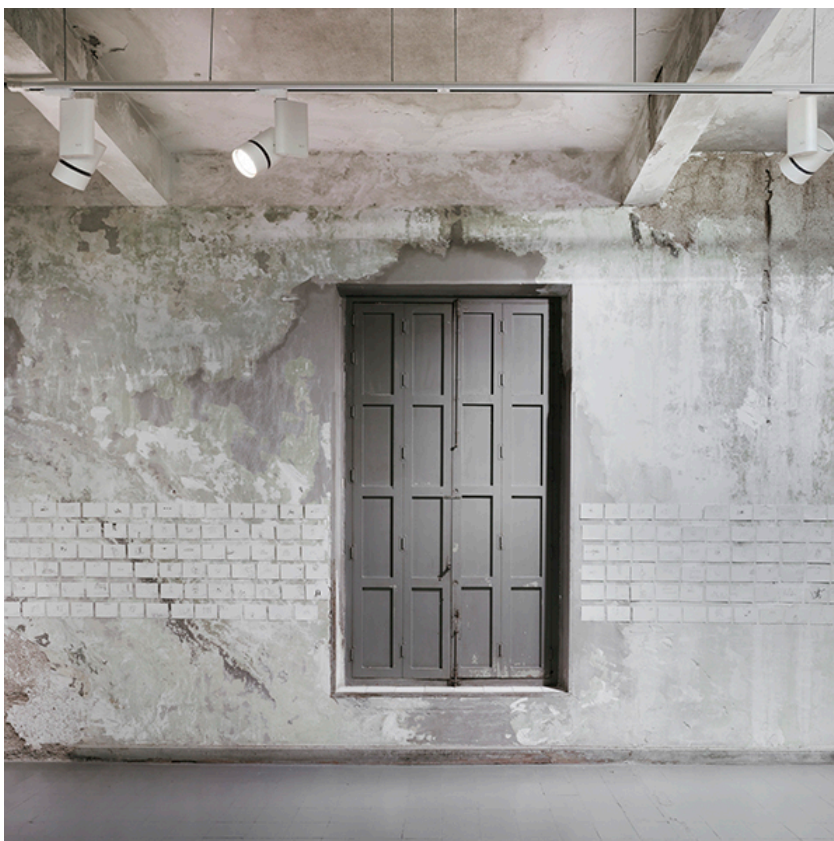
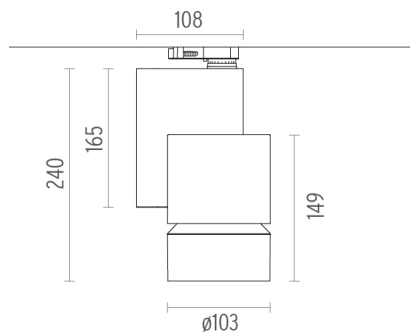

CERTIFICATIONS

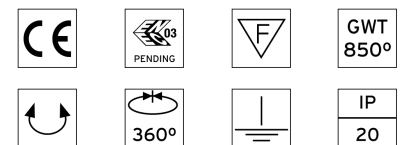

Solid Pure Track Dali Version . Accessories

Optical



08.8768.14

Holding ring

Holding ring



08.8763.14

Honeycomb anti-glare screen

"Honeycomb" anti-glare screen: in thin, black-painted aluminium sheets.

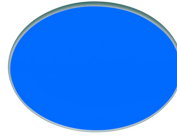

08.8766.64.OD

Blue filter

Blue filter



08.8766.65.OD

Sky blue filter

Sky blue filter



08.8766.66.OD

Amber filter

Amber filter

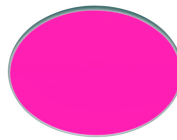

08.8766.67.OD

Red filter

Red filter



Solid Pure Track Dali Version designed by Knud Holscher

Spotlight to be installed on 3-circuit-track with LED light source. Integrated power supply 220-240V / 50-60Hz.

09.2880.30.DA - 3200lm White

09.2880.14.DA - 3200lm Black

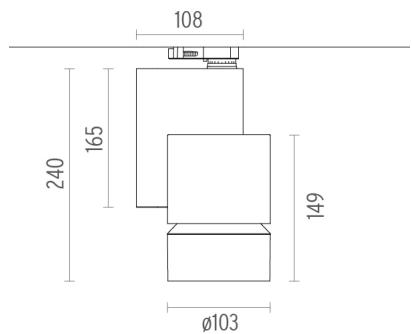

CERTIFICATIONS



Solid Pure Track Dali Version . Lamps



LED Array

Lamp category:

LED

Socket:

Special base

Lamp type:

LED Array



Solid Pure Track Dali Version
designed by Knud Holscher

Spotlight to be installed on 3-circuit-track with LED light source. Integrated power supply 220-240V / 50-60Hz.

- 09.2880.30.DA - 3200lm White
- 09.2880.14.DA - 3200lm Black

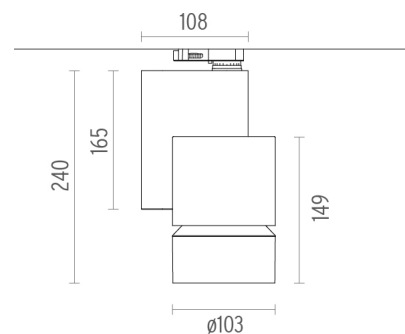

CERTIFICATIONS

