

FLOS

PURE 3 SPOT PRO CEILING

Number of heads	1
Mounting	Ceiling surface
Lamps description	QR-111 G53 Max 100W or LED QR-111 G53
Voltage (V)	220/240
Environment	Indoor
Notes	Please ask Flos architectural sales team about QR-111 lamps LED retrofit compatibility.



Pure 3 Spot Pro Ceiling
designed by Knud Holscher

Spotlight to be installed on ceiling/wall. Electronic transformer integrated 220/240V – 12V, 50/60Hz. Dimmable from 10% to 100% of full output using built-in potentiometer.

OPTICAL

Light controller description	Bare lamps
Reflector finish	Aluminum
Aiming	Adjustable
Light distribution symmetry	Symmetric
Beam angle	24°, 25°, 36°, 45°, 6°, 8°

ELECTRICAL

Transformer availability	Included
Transformer mounting	Integral
Transformer type	Electronic dimmable
Emergency	Without
Insulation class	Class I

● 09.1988.30	White
● 09.1988.02	Grey
● 09.1988.14	Black

PHYSICAL

Width (mm)	249
Spot diameter (mm)	135
Construction material	Aluminium
Weight (kg)	2,30

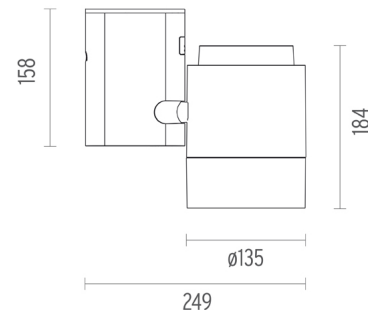

CERTIFICATIONS

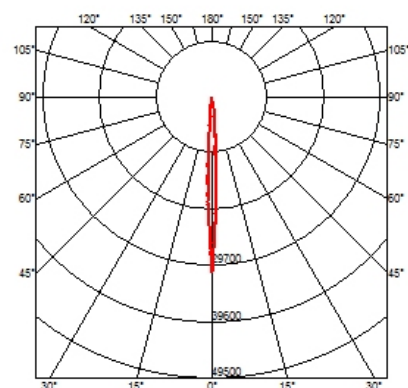
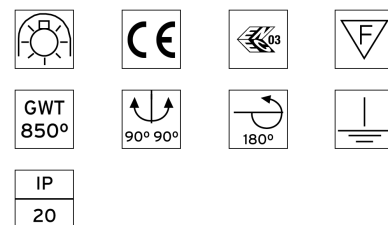

Pure 3 Spot Pro Ceiling . Accessories

Optical



08.8165.68

Elliptical light distribution lens

Elliptical light distribution lens in 4mm thick tempered glass.

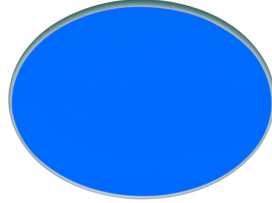

08.8162.64.OD

Blue filter

Blue filter

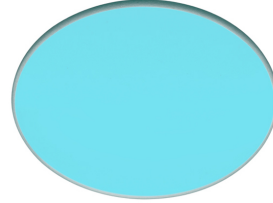

08.8162.65.OD

Sky blue filter

Sky blue filter



Pure 3 Spot Pro Ceiling designed by Knud Holscher

Spotlight to be installed on ceiling/wall. Electronic transformer integrated 220/240V – 12V, 50/60Hz. Dimmable from 10% to 100% of full output using built-in potentiometer.

	09.1988.30	White
	09.1988.02	Grey
	09.1988.14	Black

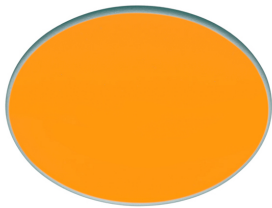

08.8162.66.OD

Amber filter

Amber filter

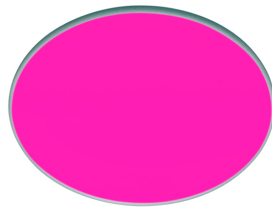

08.8162.67.OD

Red filter

Red filter



08.8162.98.OD

U.V. filter

U.V. filter

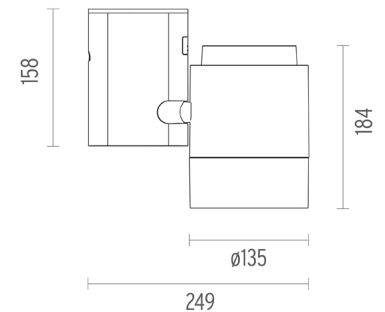

08.8162.68

I.R. filter

I.R. filter

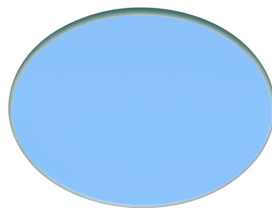

08.8162.CL

Cold light filter

Cold light filter

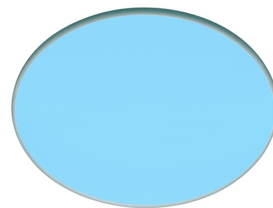

08.8162.DL

Daylight filter

Daylight filter

CERTIFICATIONS

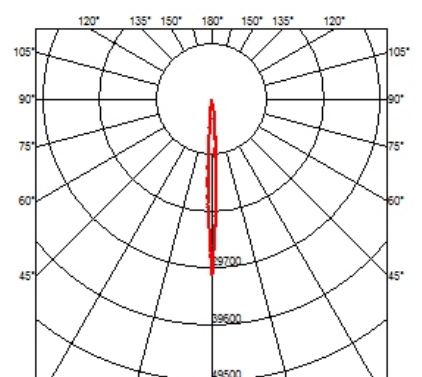

Pure 3 Spot Pro Ceiling . Accessories

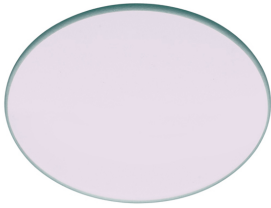

08.8162.ND

Neodimium

Neodimium



08.8162.69

Hot Light

Hot Light



08.8177.68

Flood lens



Flood lens made in press glass.



Pure 3 Spot Pro Ceiling

designed by Knud Holscher

Spotlight to be installed on ceiling/wall. Electronic transformer integrated 220/240V – 12V, 50/60Hz. Dimmable from 10% to 100% of full output using built-in potentiometer.

-  09.1988.30 White
-  09.1988.02 Grey
-  09.1988.14 Black



08.8198.14

Honeycomb

Anti-glare grid in aluminium cells with black liquid paint finish.

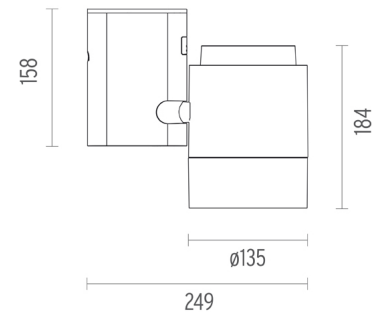

CERTIFICATIONS

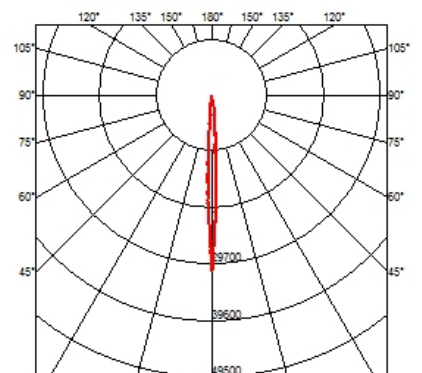
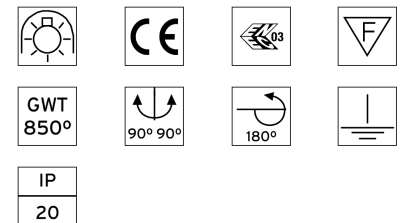

FLOS

Pure 3 Spot Pro Ceiling . Lamps



60.6398

QR-III

Lamp Watt:
35 W

Lamp category:
Halogen low voltage

Socket:
G53

Lamp angle:
24 °

Color temperature (K):
3000 °K

Catalog reference:
60.6398

Lamp type:
QR-III



60.6374

QR-III

Lamp Watt:
50 W

Lamp category:
Halogen low voltage

Socket:
G53

Lamp angle:
24 °

Color temperature (K):
3000 °K

Catalog reference:
60.6374

Lamp type:
QR-III



60.6375

QR-III

Lamp Watt:
75 W

Lamp category:
Halogen low voltage

Socket:
G53

Lamp angle:
8 °

Color temperature (K):
3000 °K

Catalog reference:
60.6375

Lamp type:
QR-III



Pure 3 Spot Pro Ceiling
designed by Knud Holscher

Spotlight to be installed on ceiling/
wall. Electronic transformer
integrated 220/240V – 12V, 50/60Hz.
Dimmable from 10% to 100% of full
output using built-in potentiometer.

● 09.1988.30	White
● 09.1988.02	Grey
● 09.1988.14	Black

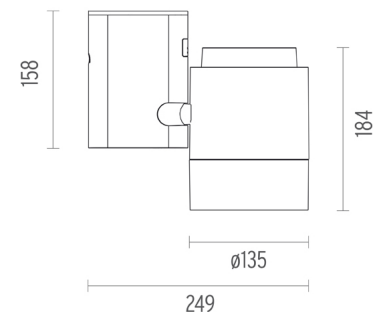

60.6376

QR-III

Lamp Watt:
75 W

Lamp category:
Halogen low voltage

Socket:
G53

Lamp angle:
24 °

Color temperature (K):
3000 °K

Catalog reference:
60.6376

Lamp type:
QR-III



60.6862

QR-III

Lamp Watt:
30 W

Lamp category:
Halogen low voltage

Socket:
G53

Lamp angle:
8 °

Color temperature (K):
3000 °K

Catalog reference:
60.6862

Lamp type:
QR-III



60.6861

QR-III

Lamp Watt:
45 W

Lamp category:
Halogen low voltage

Socket:
G53

Lamp angle:
45 °

Color temperature (K):
3000 °K

Catalog reference:
60.6861

Lamp type:
QR-III

CERTIFICATIONS

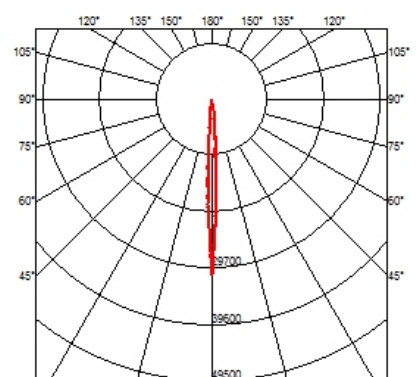
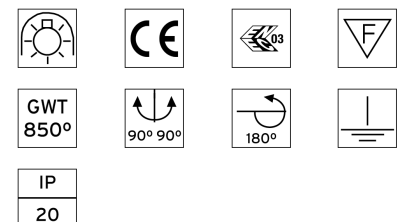

Pure 3 Spot Pro Ceiling . Lamps



60.6863

QR-III

Lamp Watt:

60 W

Lamp category:

Halogen low voltage

Socket:

G53

Lamp angle:

8 °

Color temperature (K):

3000 °K

Catalog reference:

60.6863

Lamp type:

QR-III



60.6864

QR-III

Lamp Watt:

60 W

Lamp category:

Halogen low voltage

Socket:

G53

Lamp angle:

24 °

Color temperature (K):

3000 °K

Catalog reference:

60.6864

Lamp type:

QR-III



60.6962

LED QR-III

Lamp Watt:

12 W

Lamp category:

LED

Socket:

G53

Lamp angle:

24 °

Color temperature (K):

2800 °K

Catalog reference:

60.6962

Lamp type:

LED QR-III



Pure 3 Spot Pro Ceiling
designed by Knud Holscher

Spotlight to be installed on ceiling/wall. Electronic transformer integrated 220/240V – 12V, 50/60Hz. Dimmable from 10% to 100% of full output using built-in potentiometer.

● 09.1988.30	White
● 09.1988.02	Grey
● 09.1988.14	Black

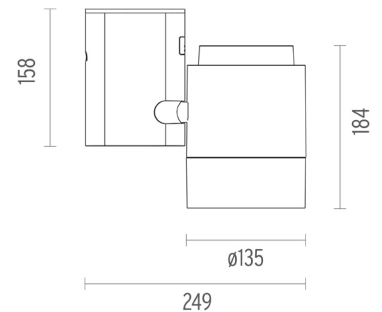

60.6989

QR-III

Lamp Watt:

50 W

Lamp category:

Halogen low voltage

Socket:

G53

Lamp angle:

6 °

Color temperature (K):

3000 °K

Catalog reference:

60.6989

Lamp type:

QR-III

CERTIFICATIONS

