

MICRO BATTERY FIXED

Number of heads	1
Mounting	Ceiling recessed
Lamps description	LED Array DC 500 mA 9,2 W 810 lm 3000K CRI 90
Luminaire luminous flux	Extreme Cut-off. See reference number
Environment	Indoor

OPTICAL

Aiming	Fixed
Light distribution symmetry	Symmetric
Beam angle	25° Medium

ELECTRICAL

Transformer availability	Separate item
Transformer mounting	Remote
Transformer type	Electronic, Electronic dimmable, Electronic dimmable I-10V, Electronic dimmable dali
Emergency	Without
Insulation class	Class III

PHYSICAL

Cutout diameter (mm)	98
Recessed depth (mm)	100
Construction material	Die-cast aluminum
Weight (kg)	0,36

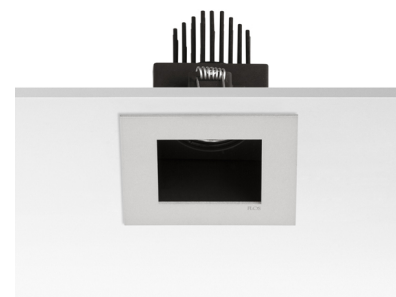

Micro Battery Fixed
designed by F.A. Porsche

Embedded luminaire for LED light source. Power supply not included.

● 04.6334.20B - 574lm	Matt white
● 04.6334.08B - 574lm	Mercury
● 04.6334.14B - 574lm	Matt black

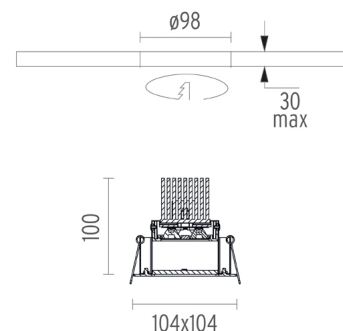

CERTIFICATIONS

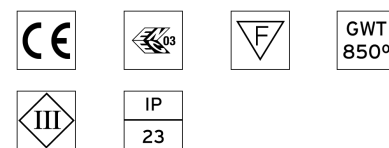

Micro Battery Fixed . Accessories

Power Supply



60.8650

Constant Current Power Supply for LED. 20W / 500 mA

Non dimmable continuous current power supply 220/240V - 50/60Hz. (110V = 12W)

Maximum length of 1.5 mm² secondary conductor (m): 50

Maximum length of 2.5 mm² secondary conductor (m): 50



60.8534

Constant Current Power Supply for LED. 32W

Continuous current power supply of 32W, 230/240V - 50/60Hz with power current selected through adjustable 350/500/700 mA switch by trailing and leading edge dimming or push dimming.

Maximum length of 1.5 mm² secondary conductor (m): 10

Maximum length of 2.5 mm² secondary conductor (m): 15



60.8533

Constant Current Power Supply for LED. 25W

Continuous current power supply of 25W, 120-240V - 50/60Hz with power current selected through adjustable 350/500/700mA 1-10V switch or push dimming.

Maximum length of 1.5 mm² secondary conductor (m): 10

Maximum length of 2.5 mm² secondary conductor (m): 15



60.8530

Constant Current Power Supply for LED. 25-50W

Continuous current power supply of 25-50W, 220/240V - 50/60Hz with power current selected through adjustable 350/500/550/650/700/750/850/900/1050mA Dali switch, 1-10V switch or push dimming.

Maximum length of 1.5 mm² secondary conductor (m): 10

Maximum length of 2.5 mm² secondary conductor (m): 15

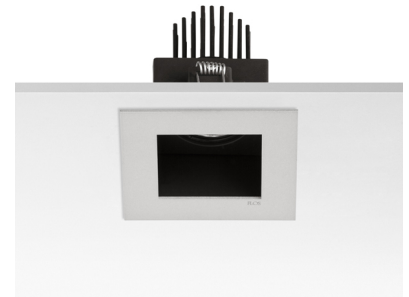

Micro Battery Fixed designed by F.A. Porsche

Embedded luminaire for LED light source. Power supply not included.

- 04.6334.20B - 574lm Matt white
- 04.6334.08B - 574lm Mercury
- 04.6334.14B - 574lm Matt black

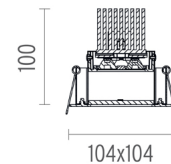
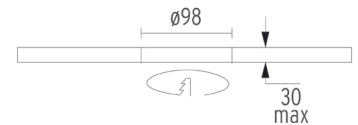

CERTIFICATIONS



Micro Battery Fixed . Lamps

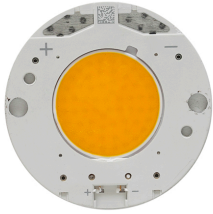

LED Array

Lamp category:
LED

Socket:
Special base

Lamp type:
LED Array



Micro Battery Fixed
designed by F.A. Porsche

Embedded luminaire for LED light source. Power supply not included.

- 04.6334.20B - 574lm Matt white
- 04.6334.08B - 574lm Mercury
- 04.6334.14B - 574lm Matt black

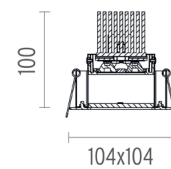
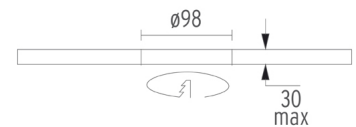

CERTIFICATIONS

