

MICRO BATTERY ADJUSTABLE

| | |
|--------------------------|---|
| Number of heads | 1 |
| Mounting | Ceiling recessed |
| Lamps description | PAR 16 GZ10 Max 50W or LED PAR 16 GZ10 4W |
| Voltage (V) | 220/240 |
| Environment | Indoor |

OPTICAL

| | |
|-------------------------------------|--------------------|
| Light controller description | Bare lamps |
| Aiming | Adjustable |
| Light distribution symmetry | Symmetric |
| Beam angle | 25°, 35°, 40°, 50° |

ELECTRICAL

| | |
|-------------------------|----------|
| Emergency | Without |
| Insulation class | Class II |

PHYSICAL

| | |
|------------------------------|-------------------|
| Cutout length (mm) | 93 |
| Cutout width (mm) | 80 |
| Recessed depth (mm) | 165 |
| Construction material | Die-cast aluminum |
| Weight (kg) | 0,43 |

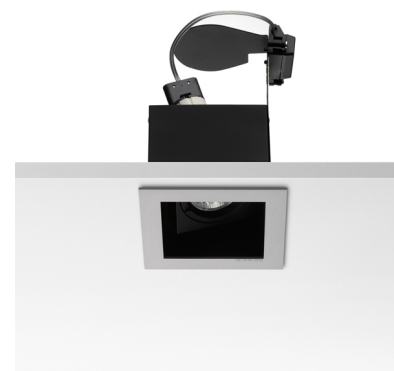

Micro Battery Adjustable
designed by F.A. Porsche

Recessed downlight with main voltage source

| | |
|--------------|------------|
| ● 04.6307.20 | Matt white |
| ● 04.6307.08 | Mercury |
| ● 04.6307.14 | Matt black |

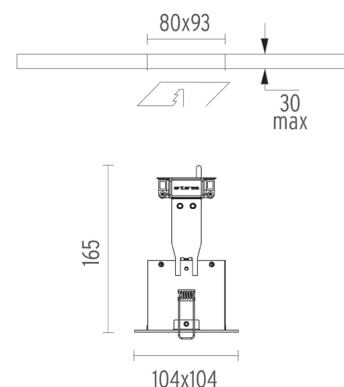

CERTIFICATIONS

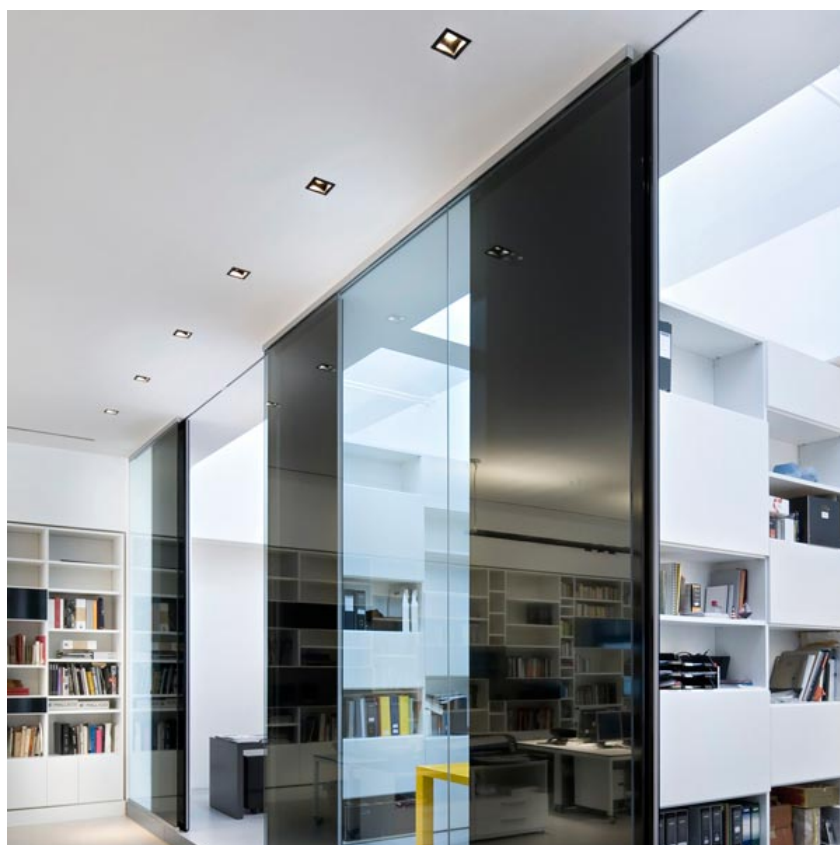
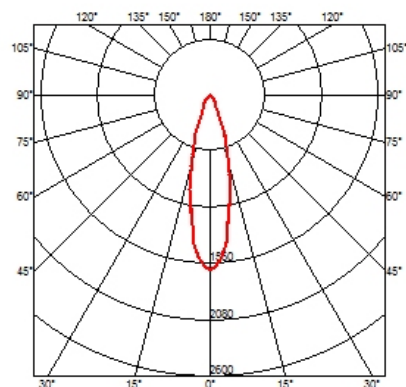
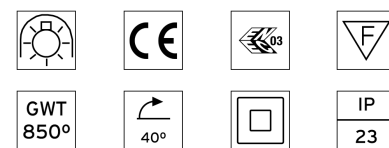

Micro Battery Adjustable . Accessories

Optical



08.8270.14

Honeycomb

Anti-glare cylinder. Cut-off 40°. Not compatible with LED versions.



Micro Battery Adjustable
designed by F.A. Porsche

Recessed downlight with main voltage source

- 04.6307.20 Matt white
- 04.6307.08 Mercury
- 04.6307.14 Matt black

Micro Battery Adjustable . Lamps



60.6365

PAR 16

Lamp Watt:
50 W

Lamp category:
Halogen mains

Socket:
GU10

Lamp angle:
35 °

Color temperature (K):
2900 °K

Catalog reference:
60.6365

Lamp type:
PAR 16



60.6396

PAR 16

Lamp Watt:
50 W

Lamp category:
Halogen mains

Socket:
GU10

Lamp angle:
50 °

Color temperature (K):
2900 °K

Catalog reference:
60.6396

Lamp type:
PAR 16



60.6693

LED PAR 16

Lamp Watt:
4 W

Lamp category:
LED

Socket:
GU10

Lamp angle:
25 °

Color temperature (K):
2700 °K

Catalog reference:
60.6693

Lamp type:
LED PAR 16

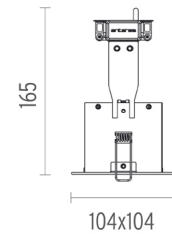
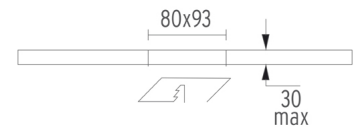

CERTIFICATIONS

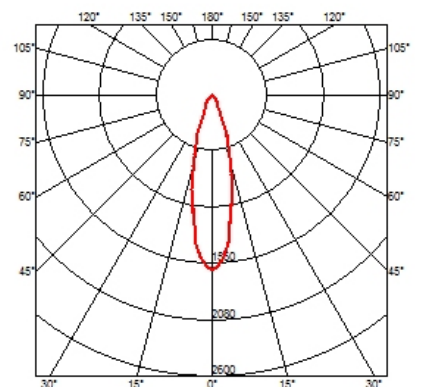
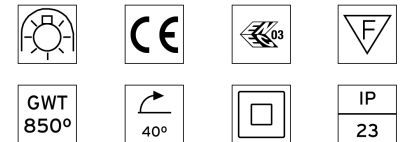

Micro Battery Adjustable . Lamps



60.6694

LED PAR 16

Lamp Watt:
4 W

Lamp category:
LED

Socket:
GU10

Lamp angle:
40 °

Color temperature (K):
2700 °K

Catalog reference:
60.6694

Lamp type:
LED PAR 16



60.6695

LED PAR 16

Lamp Watt:
4 W

Lamp category:
LED

Socket:
GU10

Lamp angle:
25 °

Color temperature (K):
3000 °K

Catalog reference:
60.6695

Lamp type:
LED PAR 16



Micro Battery Adjustable
designed by F.A. Porsche

Recessed downlight with main voltage source

- 04.6307.20 Matt white
- 04.6307.08 Mercury
- 04.6307.14 Matt black

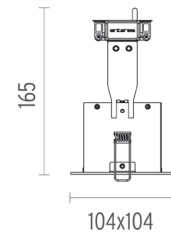
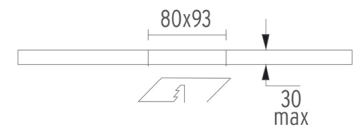

CERTIFICATIONS

