

BATTERY TRIM LARGE 2L

Number of heads	2
Mounting	Ceiling recessed
Lamps description	2 x QR-III G53 Max 100W or 2 x LED QR-III G53
Voltage (V)	12
Environment	Indoor
Notes	Please ask Flos architectural sales team about QR-III lamps LED retrofit compatibility.

OPTICAL

Light controller description	Bare lamps
Aiming	Adjustable
Light distribution symmetry	Symmetric
Beam angle	24°, 25°, 36°, 45°, 6°, 8°

ELECTRICAL

Transformer availability	Separate item
Transformer mounting	Remote
Transformer type	Electronic, Electronic dimmable
Emergency	Without
Insulation class	Class III

PHYSICAL

Recessed depth (mm)	128
Construction material	Aluminium
Weight (kg)	1,96



Battery Trim Large 2L
designed by F.A. Porsche

12V halogen lamp recessed downlight.
Remote transformer not included

● 04.6002.20	Matt white
● 04.6002.08	Mercury
● 04.6002.14	Matt black

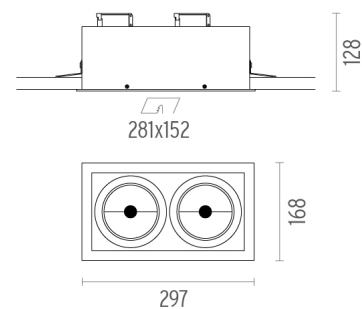

CERTIFICATIONS

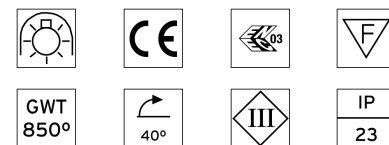

Battery Trim Large 2L . Accessories

Optical



- 08.8025.20
- 08.8025.08
- 08.8025.14

Elliptical light distribution lens

Elliptical light distribution lens in 4mm thick tempered glass.



- 08.8029.20
- 08.8029.08
- 08.8029.14

Honeycomb

Anti-glare grid made of aluminium cells.



- 08.8030.20
- 08.8030.08
- 08.8030.14

Screening cylinder

Screening cylinder with rotating pin in a black thermoplastic material



Battery Trim Large 2L designed by F.A. Porsche

12V halogen lamp recessed downlight.
Remote transformer not included

- 04.6002.20 Matt white
- 04.6002.08 Mercury
- 04.6002.14 Matt black

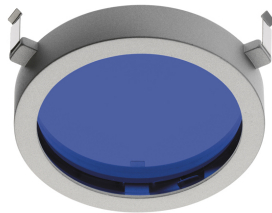

- 08.8027.20.AO
- 08.8027.08.AO
- 08.8027.14.AO

Blue filter

Blue filter

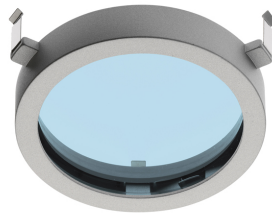

- 08.8027.20.AC
- 08.8027.08.AC
- 08.8027.14.AC

Sky blue filter

Sky blue filter

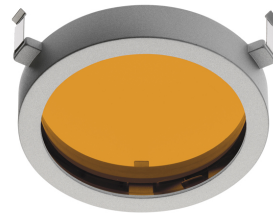

- 08.8027.20.AM
- 08.8027.08.AM
- 08.8027.14.AM

Amber filter

Amber filter

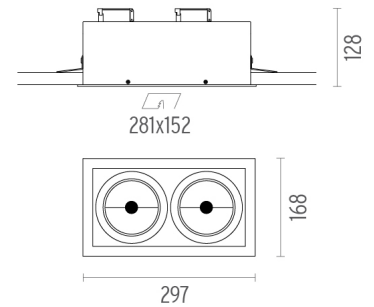

CERTIFICATIONS

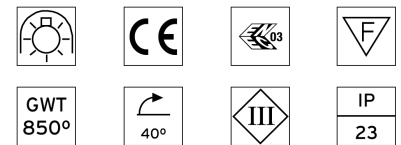

Battery Trim Large 2L . Accessories

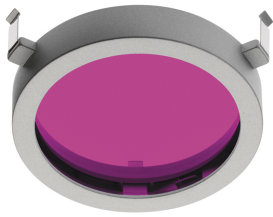

- 08.8027.20.RO
- 08.8027.08.RO
- 08.8027.14.RO

Red filter

Red filter

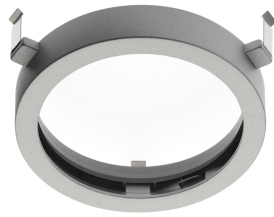

- 08.8027.20.UV
- 08.8027.08.UV
- 08.8027.14.UV

U.V. filter

U.V. filter

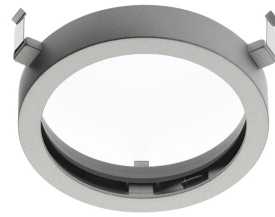

- 08.8027.20.IR
- 08.8027.08.IR
- 08.8027.14.IR

I.R. filter

I.R. filter

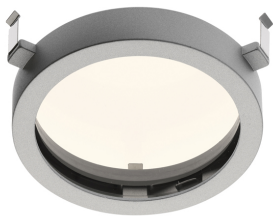

- 08.8027.08.HL
- 08.8027.20.HL
- 08.8027.14.HL

Hot Light

Hot Light

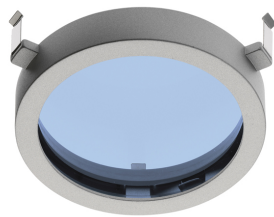

- 08.8027.20.CL
- 08.8027.08.CL
- 08.8027.14.CL

Cold light filter

Cold light filter

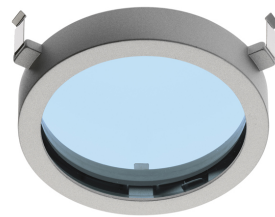

- 08.8027.20.DL
- 08.8027.08.DL
- 08.8027.14.DL

Daylight filter

Daylight filter



Battery Trim Large 2L

designed by F.A. Porsche

12V halogen lamp recessed downlight.
Remote transformer not included

- 04.6002.20 Matt white
- 04.6002.08 Mercury
- 04.6002.14 Matt black

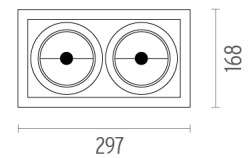
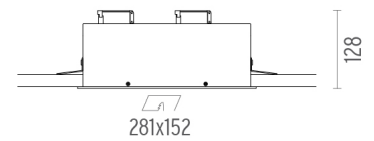

CERTIFICATIONS



Battery Trim Large 2L . Accessories



- 08.8027.20.ND
- 08.8027.08.ND
- 08.8027.14.ND

Neodimium

Neodimium

- 08.8180.20
- 08.8180.08
- 08.8180.14

Flood lens made in press glass



Battery Trim Large 2L
designed by F.A. Porsche

12V halogen lamp recessed downlight.
Remote transformer not included

- 04.6002.20 Matt white
- 04.6002.08 Mercury
- 04.6002.14 Matt black

Battery Trim Large 2L . Lamps

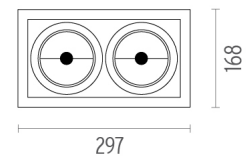
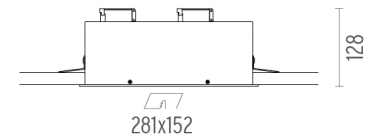

60.6398

QR-III

Lamp Watt:
35 W

Lamp category:
Halogen low voltage

Socket:
G53

Lamp angle:
24 °

Color temperature (K):
3000 °K

Catalog reference:
60.6398

Lamp type:
QR-III

60.6374

QR-III

Lamp Watt:
50 W

Lamp category:
Halogen low voltage

Socket:
G53

Lamp angle:
24 °

Color temperature (K):
3000 °K

Catalog reference:
60.6374

Lamp type:
QR-III

60.6375

QR-III

Lamp Watt:
75 W

Lamp category:
Halogen low voltage

Socket:
G53

Lamp angle:
8 °

Color temperature (K):
3000 °K

Catalog reference:
60.6375

Lamp type:
QR-III

CERTIFICATIONS



Battery Trim Large 2L . Lamps



60.6376

QR-III

Lamp Watt:
75 W

Lamp category:
Halogen low voltage

Socket:
G53

Lamp angle:
24 °

Color temperature (K):
3000 °K

Catalog reference:
60.6376

Lamp type:
QR-III



60.6862

QR-III

Lamp Watt:
30 W

Lamp category:
Halogen low voltage

Socket:
G53

Lamp angle:
8 °

Color temperature (K):
3000 °K

Catalog reference:
60.6862

Lamp type:
QR-III



60.6861

QR-III

Lamp Watt:
45 W

Lamp category:
Halogen low voltage

Socket:
G53

Lamp angle:
45 °

Color temperature (K):
3000 °K

Catalog reference:
60.6861

Lamp type:
QR-III



60.6863

QR-III

Lamp Watt:
60 W

Lamp category:
Halogen low voltage

Socket:
G53

Lamp angle:
8 °

Color temperature (K):
3000 °K

Catalog reference:
60.6863

Lamp type:
QR-III



60.6864

QR-III

Lamp Watt:
60 W

Lamp category:
Halogen low voltage

Socket:
G53

Lamp angle:
24 °

Color temperature (K):
3000 °K

Catalog reference:
60.6864

Lamp type:
QR-III



60.6962

LED QR-III

Lamp Watt:
12 W

Lamp category:
LED

Socket:
G53

Lamp angle:
24 °

Color temperature (K):
2800 °K

Catalog reference:
60.6962

Lamp type:
LED QR-III



Battery Trim Large 2L
designed by F.A. Porsche

12V halogen lamp recessed downlight.
Remote transformer not included

- 04.6002.20 Matt white
- 04.6002.08 Mercury
- 04.6002.14 Matt black

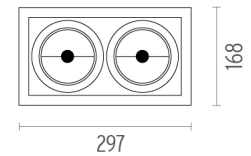
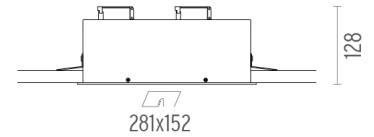

CERTIFICATIONS



Battery Trim Large 2L . Lamps



60.6989

QR-III

Lamp Watt:

50 W

Lamp category:

Halogen low voltage

Socket:

G53

Lamp angle:

6°

Color temperature (K):

3000 °K

Catalog reference:

60.6989

Lamp type:

QR-III

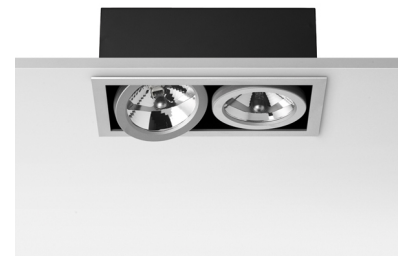

Battery Trim Large 2L

designed by F.A. Porsche

12V halogen lamp recessed downlight.
Remote transformer not included

● 04.6002.20	Matt white
● 04.6002.08	Mercury
● 04.6002.14	Matt black

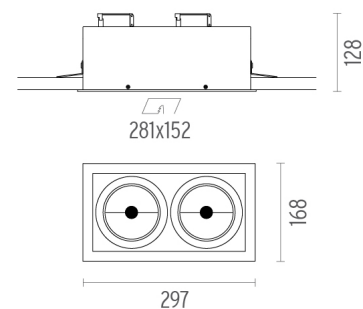

CERTIFICATIONS

