

Fabbian

50 via Santa Brigida
31020 Castelminio di Resana
Treviso, Italy Tel +39 0423 4848 fax +39 423 484395
fabbian@fabbian.com www.fabbian.com

CRICKET D60G07

I

ATTENZIONE: LA SICUREZZA DELL'APPARECCHIO È GARANTITA SOLO CON L'USO APPROPRIATO DELLE SEGUENTI ISTRUZIONI. CONSERVARLE CON CURA.

AVVERTENZE

Prima di eseguire qualsiasi tipo di operazione togliere la tensione in rete.
Fare attenzione a non superare il Max di watt indicati per l'apparecchio.
L'apparecchio non può essere usato in ambienti umidi o all'esterno.
Mai coprire l'apparecchio durante l'impiego.

L'apparecchio deve essere equipaggiato con lampade autoprotette che non necessitano di schermo di protezione.

Potenza massima della lampada. 1x20W 12V

Frequenza nominale. 50/60 Hz

Attacco lampada. GU4

Tipo lampada. 

Apparecchio classe III. 

Classe di protezione. IP20 

Adatto al montaggio su superfici normalmente infiammabili.

Per il collegamento elettrico, usare cavi resistenti al calore 

GB

ATTENTION: THE SAFETY OF THE APPLIANCE IS GUARANTEED ONLY IF IT IS PROPERLY USED, ACCORDING TO THE FOLLOWING INSTRUCTIONS, WHICH ARE TO BE KEPT.

WARNING

Always disconnect the power supply before installing or performing any maintenance operations.
Make attention of not exceeding the maximum watt indicated on the appliance.
The appliance may not be used in humid or external environments.
Never cover the appliance while in function.

The symbol mains the use of self-protection lamps which don't need of any protection screen.

Capacity of bulb. 1x20W 12V

Rated frequency. 50/60 Hz

Type of lampholder. GU4

Type of bulb. 

Appliance in class III. 

Protection class. IP20 

Adaptable for mounting onto surfaces normally inflammable.

For the electric connection, use heat resisting cables 

D

ACHTUNG: DIE SICHERHEIT DIESER BELEUCHTUNGSKÖRPERS WIRD NUR DURCH DIE KORREKTE ANWENDUNG DER NACHSTEHENDEN ANWEISUNGEN GEWÄHRLEISTET. DIESE ÜSSEN DAHER SORGFÄLIG AUFBEWAHRT WERDEN: WICHTIGE HINWEISE

Bevor irgendwelche Arbeitsgänge ausgeführt werden, muß die Stromversorgung unterbrochen.
Achten Sie darauf, daß die auf dem Beleuchtungskörper angegebene maximale Wattzahl nicht überschritten wird.
Der Beleuchtungskörper darf nicht in feuchten Räumen bzw. im Freien eingesetzt werden.
Den Beleuchtungskörper während dem Betrieb nicht abdecken.

The symbol mains the use of self-protection lamps which don't need of any protection screen.

Leistung der Gluebirne. 1x20W 12V

Nennfrequenz. 50/60 Hz

Anschluss. GU4

Typ der Gluebirne. 

Gerat der Klasse III. 

Schutzklasse. IP20 

Das Gerat eignet sich fuer die Montage auf normal entflammaren Oberflaechen.

Warmfeste Kabel fuer die Verbindung brauchen 

RU

ВНИМАНИЕ: БЕЗОПАСНОСТЬ ОСВЕТИТЕЛЬНОГО ПРИБОРА ГАРАНТИРОВАНА ТОЛЬКО ПРИ УСЛОВИИ ЕГО ЭКСПЛУАТАЦИИ В СООТВЕТСТВИИ С ПРИВЕДЕННЫМИ НИЖЕ ИНСТРУКЦИЯМИ, КОТОРЫЕ НЕОБХОДИМО СОХРАНИТЬ. ВНИМАНИЕ:

Перед выполнением любой операции с осветительным прибором отключить напряжение в сети.
Не превышать максимально допустимую мощность, указанную для данного осветительного прибора.
Осветительный прибор не может быть использован во влажных помещениях или на улице.
Никогда не накрывать осветительный прибор в рабочем режиме.

Рекомендуется снабжать осветительный прибор самозащищенными лампочками, не нуждающимися в защитного экрана.

Максимальная мощность лампочки. 1x20W 12V

Номинальная частота. 50/60 Hz

Тип цоколя лампочки. GU4

Тип лампочки. 

Осветительный прибор КЛАССА III. 

Класс защиты. IP20 

пригодный для установки на возгораемых поверхностях.

For the electric connection, use heat resisting cables 

F

ATTENTION: LA SECURITE DE CET APPAREIL N'EST GARANTIE QUE SI L'ON RESPECTE LES INSTRUCTIONS SUIVANTES. IL EST, PAR CONSEQUENT, INDISPENSABLE DE LES CONSERVER SOIGNEUSEMENT.

AVERTISSEMENTS

Avant d'effectuer toute opération, débrancher la tension de réseau.
Veiller à ne pas dépasser la limite maximale des watts indiquée sur l'appareil.
Cet appareil ne peut pas être utilisé dans des pièces humides ni à l'extérieur.
Ne jamais couvrir l'appareil pendant son fonctionnement.

L'appareil doit etre equipe avec ampoules masquées. Ecran de protection non necessaire.

Puissance ampoule. 1x20W 12V

Fréquence assignée. 50/60 Hz

Culot. GU4

Type ampoule. 

Appareil de classe III. 

Classe de protection. IP20 

Appareil apte au montage sur surfaces normalement inflammables

Pour la connexion électrique utiliser des câbles résistant à la chaleur 

P

ATENÇÃO: A SEGURANÇA DO APARELHO É GARANTIDA SOMENTE SE FOREM RESPEITADAS AS INSTRUÇÕES. PORTANTO, É NECESSÁRIO CONSERVÁ-LAS. ADVERTÊNCIAS

Antes de fazer qualquer tipo de operação, desligar a corrente eléctrica da rede.
Prestar atenção para não superar o número de watts indicados para o aparelho.
O aparelho não pode ser utilizado em ambientes húmidos ou no exterior.
Nunca cobrir o aparelho durante o funcionamento.

Este símbolo significa o uso de lâmpadas protegidas, as quais não necessitam proteção adicional.

Potência máxima da lâmpada. 1x20W 12V

Frequência nominal. 50/60 Hz

Tipo de suporte da lâmpada. GU4

Tipo de lâmpada. 

Aparelho de CLASSE III. 

Classe de protecção. IP20 

Apropriado para ser montado em superficies normalmente inflamáveis.

For the electric connection, use heat resisting cables 

E

ATENCIÓN: LA SEGURIDAD DEL APARATO ESTÁ GARANTIZADA SÓLO POR UN USO ADECUADO DE LAS SIGUIENTES INSTRUCCIONES; POR CONSIGUIENTE, ES PRECISO CONSERVARLAS. ADVERTENCIAS

Antes de llevar a cabo cualquier tipo de operación, desconectar la tensión de la red.
Prestar atención a no superar el máximo de los vatios indicados en el aparato.
El aparato no podrá utilizarse en ambientes húmedos ni en exteriores.
No cubrir jamás el aparato durante el funcionamiento.

La lampara tiene que ser equipada con bombillas autoprotectidas que no necesitan de escudo de proteccion.

Potencia máxima de la bombilla. 1x20W 12V

Frecuencia nominal. 50/60 Hz

Casquillo de la bombilla. GU4

Tipo de bombilla. 

Aparato CLASE III. 

Clase de protección. IP20 

Aparato adecuado para el montaje en superficies normalmente inflamables.

Para la conexión, utilizen cables resistentes al calor. 

D60G07

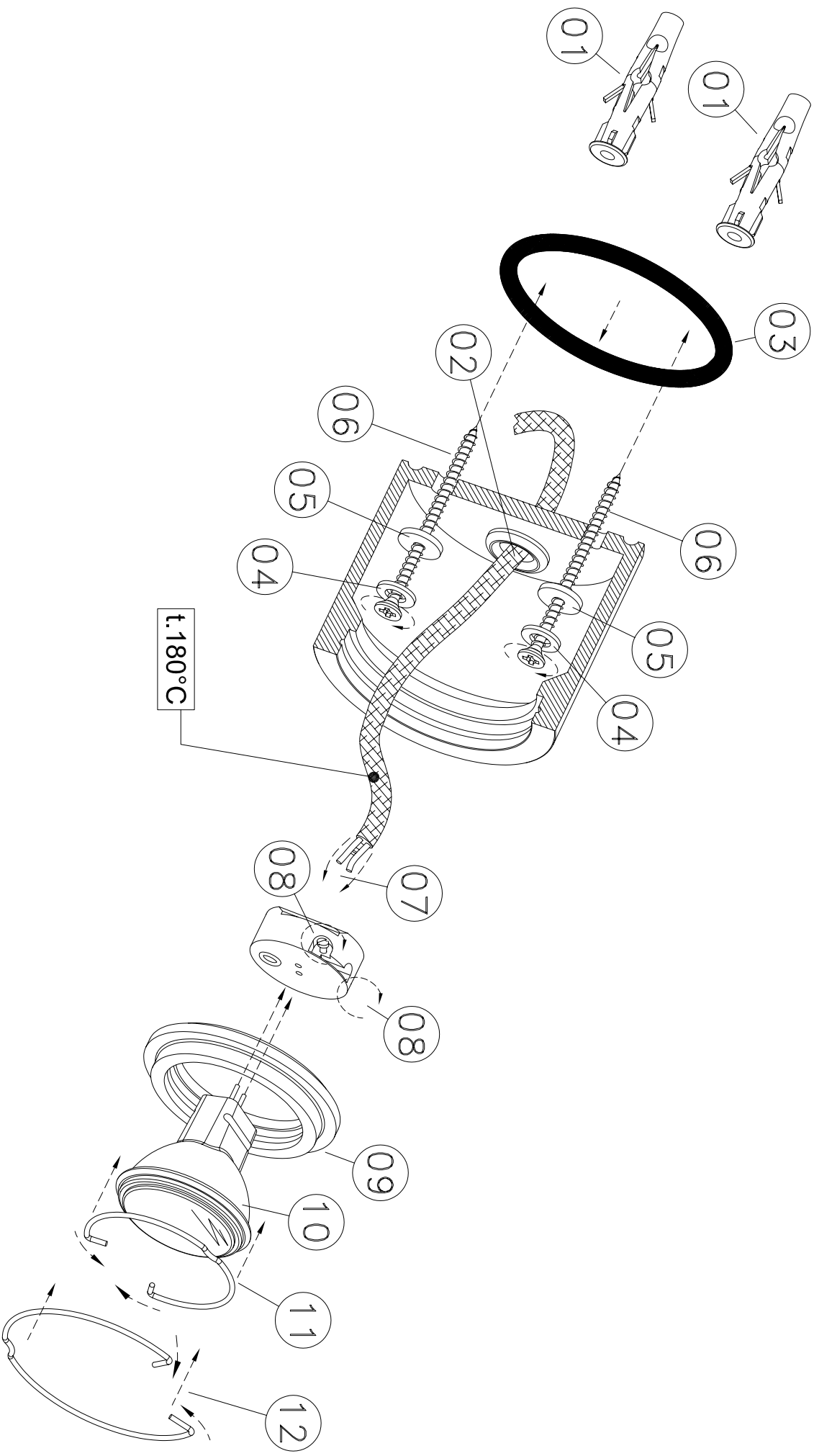

- Procedere al montaggio seguendo le operazioni in ordine numerico progressivo.
- Proceed with assembling following the operations in progressive numerical order.
- Arbeitsgänge in numerischer Ordnung ausführen, um das Gerät zu installieren.
- Il faut procéder a le montage exécutant les opérations par l'ordre numérique progressif.
- Proceder al montaje siguiendo las operaciones en orden numerico progresivo.
- Proceder a montagem seguindo as instruções em ordem numerica progressiva.