

ATTENZIONE: LA SICUREZZA DELL'APPARECCHIO È GARANTITA SOLO CON L'USO APPROPRIATO DELLE SEGUENTI ISTRUZIONI. CONSERVARLE CON CURA.

I

AVVERTENZE

Prima di eseguire qualsiasi tipo di operazione togliere la tensione in rete.

Fare attenzione a non superare il Max di watt indicati per l'apparecchio.

L'apparecchio non può essere usato in ambienti umidi o all'esterno.

L'apparecchio non deve, in nessuna circostanza, essere coperto con materiale isolante o similare.

Mai coprire l'apparecchio durante il funzionamento.

L'apparecchio deve essere equipaggiato con lampade autoprotette che non necessitano di schermo di protezione.

Le parti laterali del vano dell'incasso devono distare almeno 50 mm dal corpo dell'apparecchio.

Potenza massima della lampada. 1x 75W

Attacco lampada. GU10

Tipo lampada.  25°

Apparecchio classe II. 

Adatto al montaggio su superfici normalmente infiammabili.

Classe di protezione. IP20

Distanza minima dagli oggetti illuminati.  0.5m

GB

ATTENTION: THE SAFETY OF THE APPLIANCE IS GUARANTEED ONLY IF IT IS PROPERLY USED, ACCORDING TO THE FOLLOWING INSTRUCTIONS, WHICH ARE TO BE KEPT.

WARNING

Always disconnect the power supply before installing or performing any maintenance operations.

Make attention of not exceeding the maximum watt indicated on the appliance.

The appliance may not be used in humid or external environments.

The luminaire shall. Under no circumstance, be covered with insulating matting or similar material.

Never cover the appliance while in function.

The symbol mains the use of self-protection lamps which don't need of any protection scream.

There must be more or less a distance of 50mm between the lateral space of the hole situated in recessed ceiling and the appliance.

Minimum distance from lighted objects.  0.5m

Capacity of bulb. 1x 75W

Type of lampholder. GU10

Type of bulb.  25°

Appliance in class II. 

Adaptable for mounting onto surfaces normally inflammable

Protection class. IP20

D

ACHTUNG: DIE SICHERHEIT DIESES BELEUCHTUNGSKÖRPERS WIRD NUR DURCH DIE KORREKTE ANWENDUNG DER NACHSTEHENDEN ANWEISUNGEN GEWÄHRLEISTET. DIESE ÜSSEN DAHER SORGFÄLTIG AUFBEWAHRT WERDEN.:

WICHTIGE HINWEISE

Bevor irgendwelche Arbeitsgänge ausgeführt werden, muß die Stromversorgung unterbrochen.

Achten Sie darauf, daß die auf dem Beleuchtungskörper angegebene maximale Wattzahl nicht überschritten wird.

Der Beleuchtungskörper darf nicht in feuchten Räumen bzw. im Freien eingesetzt werden.

Das Gerät muß NIE mit Isoliermaterial oder ähnlichen Materialien bedeckt werden.

Den Beleuchtungskörper während dem Betrieb nicht abdecken.

The symbol mains the use of self-protection lamps which don't need of any protection scream.

Die Seitenwände der Unterbauöffnung müssen mindestens 50 mm vom Lampenkörper entfernt sein.

Minimum distance from lighted objects.  0.5m

Leistung der Gluehbirne. 1x 75W

Anschluss. GU10

Typ der Gluehbirne.  25°

Gerät der Klasse II. 

Schutzklasse. IP20

Das Gerät eignet sich fuer die Montage auf normal entflammaren Oberflaechen.



RU

ВНИМАНИЕ: БЕЗОПАСНОСТЬ ОСВЕТИТЕЛЬНОГО ПРИБОРА ГАРАНТИРОВАНА ТОЛЬКО ПРИ УСЛОВИИ ЕГО ЭКСПЛУАТАЦИИ В СООТВЕТСТВИИ С ПРИВЕДЕННЫМИ НИЖЕ ИНСТРУКЦИЯМИ, КОТОРЫЕ НЕОБХОДИМО СОХРАНИТЬ.

ВНИМАНИЕ:

Перед выполнением любой операции с осветительным прибором отключить напряжение в сети.

Не превышать максимально допустимую мощность, указанную для данного осветительного прибора.

Осветительный прибор не может быть использован во влажных помещениях или на улице.

The luminaire shall. Under no circumstance, be covered with insulating matting or similar material.

Никогда не накрывать осветительный прибор в рабочем режиме.

The symbol mains the use of self-protection lamps which don't need of any protection scream.

Боковые поверхности ниши должны находиться на расстоянии 50 мм от корпуса осветительного прибора. Минимальное расстояние от освещаемых предметов  0.5m

Максимальная мощность лампочки. 1x 75W

Тип цоколя лампочки. GU10

Тип лампочки.  25°

Класс защиты. IP20

Осветительный прибор КЛАССА II. 

пригодный для установки на возгораемых поверхностях.



F

ATTENTION: LA SECURITE DE CET APPAREIL N'EST GARANTIE QUE SI L'ON RESPECTE LES INSTRUCTIONS SUIVANTES. IL EST, PAR CONSEQUENT, INDISPENSABLE DE LES CONSERVER SOIGNEUSEMENT.

AVERTISSEMENTS

Avant d'effectuer toute opération, débrancher la tension de réseau.

Veiller à ne pas dépasser la limite maximale des watts indiquée sur l'appareil.

Cet appareil ne peut pas être utilisé dans des pièces humides ni à l'extérieur.

L'appareil ne doit absolument pas être recouvert avec matériel isolant ou similaire.

Ne jamais couvrir l'appareil pendant son fonctionnement.

The symbol mains the use of self-protection lamps which don't need of any protection scream.

Veiler à respecter une distance minimale de 50 mm entre le corps de l'appareil et les parois latérales du logement d'encastrement.

Puissance ampoule. 1x 75W

Culot. GU10

Type ampoule.  25°

Appareil de classe II. 

Classe de protection. IP20

Appareil apte au montage sur surfaces normalement inflammables.



Distance minime des objets eclaires.  0.5m

P

ATENÇÃO: A SEGURANÇA DO APARELHO É GARANTIDA SOMENTE SE FOREM RESPEITADAS AS INSTRUÇÕES. PORTANTO, É NECESSÁRIO CONSERVÁ-LAS.

ADVERTÊNCIAS

Antes de fazer qualquer tipo de operação, desligar a corrente eléctrica da rede.

Prestar atenção para não superar o número de watts indicados para o aparelho.

O aparelho não pode ser utilizado em ambientes húmidos ou no exterior.

The luminaire shall. Under no circumstance, be covered with insulating matting or similar material.

Nunca cobrir o aparelho durante o funcionamento.

The symbol mains the use of self-protection lamps which don't need of any protection scream.

There must be more or less a distance of 50mm between the lateral space of the ole situated in recessed ceiling and the

Minimum distance from lighted objects.  0.5m

Potência máxima da lâmpada. 1x 75W

Tipo de suporte da lâmpada. GU10

Tipo de lâmpada.  25°

Aparelho de CLASSE II. 

Apropriado para ser montado em superficies normalmente inflamáveis.

Classe de protecção. IP20



E

ATENCIÓN: LA SEGURIDAD DEL APARATO ESTÁ GARANTIZADA SÓLO POR UN USO ADECUADO DE LAS SIGUIENTES INSTRUCCIONES; POR CONSIGUIENTE, ES PRECISO CONSERVARLAS.

ADVERTENCIAS

Antes de llevar a cabo cualquier tipo de operación, desconectar la tensión de la red.

Prestar atención a no superar el máximo de los vatios indicados en el aparato.

El aparato no podrá utilizarse en ambientes húmedos ni en exteriores.

El aparato en ninguna circunstancia tiene que estar cubierto con material aislante o parecido.

No cubrir jamás el aparato durante el funcionamiento.

El aparato tiene que estar provisto de bombillas autoprotégidas que no necesitan la pantalla de protección.

Las paredes laterales del hueco del empotrado tienen que distar por los menos 50 mm del cuerpo del aparato.

Distancia mínima de los objetos alumbrados.  0.5m

Potencia máxima de la bombilla. 1x 75W

Casquillo de la bombilla. GU10

Tipo de bombilla.  25°

Aparato CLASE II. 

Clase de protección. IP 20



(D55F21)
D55F22
D55F26

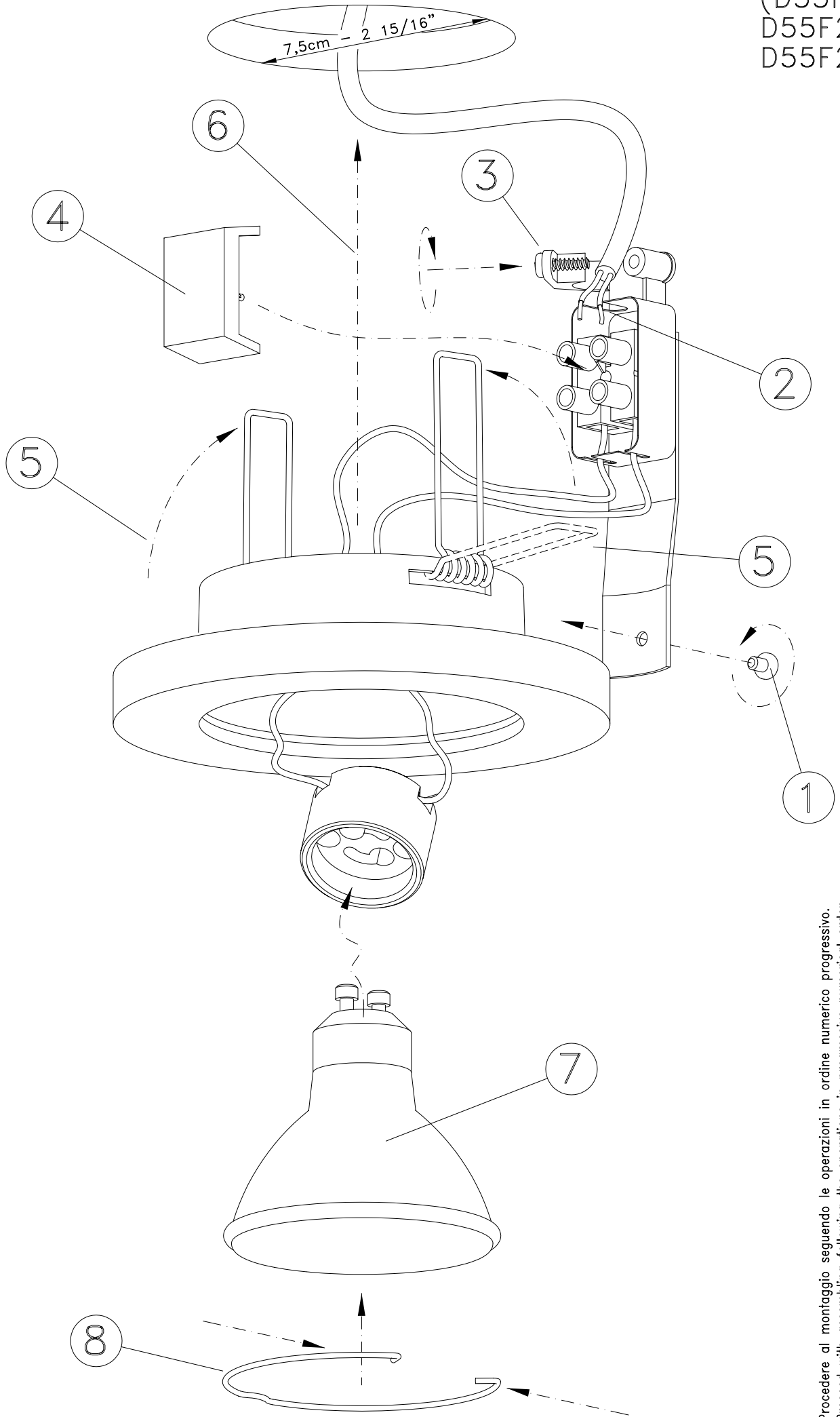

-Procedere al montaggio seguendo le operazioni in ordine numerico progressivo.
-Proceed with assembling following the operations in progressive numerical order.
-Arbeitsgänge in numerischer Ordnung ausführen, um das Gerät zu installieren.
-Il faut procéder a le montage exécutant les opérations par l'ordre numérique progressif.