

Fabbian

50 via Santa Brigida
31020 Castelmio di Resana
Treviso, Italy Tel +39 0423 4848 fax +39 423 484395
fabbian@fabbian.com www.fabbian.com

EASY
D14F37



I **ATTENZIONE: L'APPARECCHIO D'ILLUMINAZIONE AD INCASSO DEVE ESSERE APPLICATO SU UN CONTROSOFFITO CON FORO DI 100mm, CAPACE DI CONTENERE L'INTERO APPARECCHIO. LA SICUREZZA DELL'APPARECCHIO È GARANTITA SOLO CON L'USO APPROPRIATO DELLE SEGUENTI ISTRUZIONI. CONSERVARLE CON CURA.**

AVVERTENZE

Prima di eseguire qualsiasi tipo di operazione togliere la tensione in rete.
Fare attenzione a non superare il Max di watt indicati per l'apparecchio.

L'apparecchio non deve, in nessuna circostanza, essere coperto con materiale isolante o similare.
Mai coprire l'apparecchio durante il funzionamento.

Le parti laterali del vano dell'incasso devono distare almeno 50 mm dal corpo dell'apparecchio.

Potenza massima della lampada. 1x 75W
Attacco lampada. GU10
Tipo lampada. GU10 
Apparecchio classe II. 

Adatto al montaggio su superfici normalmente infiammabili.
Grado di protezione. (IP20 lato incassato), (IP44 lato vetro) IP20/IP44 

L'apparecchio deve essere equipaggiato con lampade autoprotette che non necessitano di schermo di protezione. 
Distanza minima dagli oggetti illuminati. 



GB **ATTENTION: THIS BUILT-IN APPLIANCE HAS TO BE COMPLETELY INTO A 100MM DIAMETER HOLE OF A RECESSED CEILING. THE SAFETY OF THE APPLIANCE IS GUARANTEED ONLY IF IT IS PROPERLY USED, ACCORDING TO THE FOLLOWING INSTRUCTIONS, WHICH ARE TO BE KEPT.**

WARNING

Always disconnect the power supply before installing or performing any maintenance operations.
Make attention of not exceeding the maximum watt indicated on the appliance.

The luminaire shall. Under no circumstance, be covered with insulating matting or similar material.
Never cover the appliance while in function.

There must be more or less a distance of 50mm between the lateral space of the ole situated in recessed ceiling and the appliance.

Capacity of bulb. 1x 75W
Type of lampholder. GU10
Type of bulb. GU10 
Appliance in class II. 



Adaptable for mounting onto surfaces normally inflammable
Degree of protection (IP20 boxed side), (IP44 side glass) IP20/IP44 

The symbol mains the use of self-protection lamps which don't need of any protection scream. 
Minimum distance from lighted objects. 



D **ACHTUNG: DER UNTERGEBaute BELEUCHTUNGSKÖRPER WIRD AN EINER HÄNGEDECKE MIT EINER ÖFFNUNG VON 100 MM ANBRACHT, IN WELCHER DER GESAMTE BELEUCHTUNGSKÖRPER PLATZ FINDET. DIE SICHERHEIT DIESES BELEUCHTUNGSKÖRPERS WIRD NUR DURCH DIE KORREKTE ANWENDUNG DER NACHSTEHENDEN ANWEISUNGEN GEWÄHRLEISTET. DIESE ÜSSEN DAHER SORGFÄLTIG AUFBEWAHRT WERDEN.: WICHTIGE HINWEISE**

Bevor irgendwelche Arbeitsgänge ausgeführt werden, muß die Stromversorgung unterbrochen.
Achten Sie darauf, daß die auf dem Beleuchtungskörper angegebene maximale Wattzahl nicht überschritten wird.

Das Gerät muß NIE mit Isoliermaterial oder ähnlichen Materialien bedeckt werden.
Den Beleuchtungskörper während dem Betrieb nicht abdecken.
Die Seitenwände der Unterbauöffnung müssen mindestens 50 mm vom Lampenkörper entfernt sein.

Leistung der Gluehbirne. 1x 75W
Anschluss. GU10
Typ der Gluehbirne. GU10 
Gerat der Klasse II. 

Schutzart. (IP20 geschachtelte seite), (IP44 teil glas) IP20/IP44 



Das Gerat eignet sich fuer die Montage auf normal entflammaren Oberflaechen.
The symbol mains the use of self-protection lamps which don't need of any protection scream. 
Minimum distance from lighted objects. 



RU **ВНИМАНИЕ: ВСТРОЕННЫЙ ОСВЕТИТЕЛЬНЫЙ ПРИБОР ДОЛЖЕН БЫТЬ УСТАНОВЛЕН В ОТВЕРСТИЕ В ПОДВЕСНОМ ПОТОЛКЕ, ДИАМЕТРОМ 100мм, ЧТОБЫ ПОЛНОСТЬЮ ВМЕСТИТЬ ПРИБОР. БЕЗОПАСНОСТЬ ОСВЕТИТЕЛЬНОГО ПРИБОРА ГАРАНТИРОВАНА ТОЛЬКО ПРИ УСЛОВИИ ЕГО ЭКСПЛУАТАЦИИ В СООТВЕТСТВИИ С ПРИВЕДЕННЫМИ НИЖЕ ИНСТРУКЦИЯМИ, КОТОРЫЕ НЕОБХОДИМО СОХРАНИТЬ. ВНИМАНИЕ:**



Перед выполнением любой операции с осветительным прибором отключить напряжение в сети.
Не превышать максимально допустимую мощность, указанную для данного осветительного прибора.

The luminaire shall. Under no circumstance, be covered with insulating matting or similar material.
Никогда не накрывать осветительный прибор в рабочем режиме.

There must be more or less a distance of 50mm between the lateral space of the ole situated in recessed ceiling and the appliance.

Максимальная мощность лампочки. 1x 75W
Тип цоколя лампочки. GU10
Тип лампочки. GU10 
Степень защиты. (IP20 boxed side), (IP44 side glass) IP20/IP44 

Осветительный прибор КЛАССА II. 
пригодный для установки на возгораемых поверхностях. 



The symbol mains the use of self-protection lamps which don't need of any protection scream. 
Минимальное расстояние от освещаемых 

F **ATTENTION: L'APPAREIL D'ÉCLAIRAGE A ENCASTRER DOIT ÊTRE APPLIQUÉ SUR UN FAUX PLAFOND, AYANT UN ORIFICE DE 100 MM EN MESURE DE CONTENIR TOUT L'APPAREIL. LA SECURITE DE CET APPAREIL N'EST GARANTIE QUE SI L'ON RESPECTE LES INSTRUCTIONS SUIVANTES. IL EST, PAR CONSEQUENT, INDISPENSABLE DE LES CONSERVER SOIGNEUSEMENT. AVERTISSEMENTS**



Avant d'effectuer toute opération, débrancher la tension de réseau.
Veiller à ne pas dépasser la limite maximale des watts indiquée sur l'appareil.

The luminaire shall. Under no circumstance, be covered with insulating matting or similar material.
Ne jamais couvrir l'appareil pendant son fonctionnement.

Veiler à respecter une distance minimale de 50 mm entre le corps de l'appareil et les parois latérales du logement d'encastrement.

Puissance ampoule. 1x 75W
Culot. GU10
Type ampoule. GU10 
Appareil de classe II. 

Degré de protection. (IP20 coté encaissé), (IP44 coté verre) IP20/IP44 



Appareil apte au montage sur surfaces normalement inflammables.
The symbol mains the use of self-protection lamps which don't need of any protection scream. 
Distance minime des objets eclaires. 

P **ATENÇÃO: O APARELHO DE ILUMINAÇÃO DE ENCASTRAR DEVE SER APLICADO NUM TECTO FALSO, NUM ORIFÍCIO DE 100MM, CAPAZ DE CONTER TODO O APARELHO. A SEGURANÇA DO APARELHO É GARANTIDA SOMENTE SE FOREM RESPEITADAS AS INSTRUÇÕES. PORTANTO, É NECESSÁRIO CONSERVÁ-LAS. ADVERTÊNCIAS**

Antes de fazer qualquer tipo de operação, desligar a corrente eléctrica da rede.
Prestar atenção para não superar o número de watts indicados para o aparelho.

The luminaire shall. Under no circumstance, be covered with insulating matting or similar material.
Nunca cubrir o aparelho durante o funcionamento.

There must be more or less a distance of 50mm between the lateral space of the ole situated in recessed ceiling and the appliance.

Potência máxima da lâmpada. 1x 75W
Tipo de suporte da lâmpada. GU10
Tipo de lâmpada. GU10 
Aparelho de CLASSE II. 

Apropriado para ser montado em superficies normalmente inflamáveis.
Grado de protecção. (IP20 boxed side), (IP44 side glass) IP20/IP44 



The symbol mains the use of self-protection lamps which don't need of any protection scream. 
Minimum distance from lighted objects. 

E **ATENCIÓN: EL APARATO DE ILUMINACIÓN EMPOTRABLE DEBE APLICARSE EN UN FALSO TECTO CON UN ORIFICIO DE 100MM, CAPAZ DE CONTENER EL ENTERO APARATO. LA SEGURIDAD DEL APARATO ESTA GARANTIZADA SÓLO POR UN USO ADECUADO DE LAS SIGUIENTES INSTRUCCIONES; POR CONSIGUIENTE, ES PRECISO CONSERVARLAS. ADVERTENCIAS**



Antes de llevar a cabo cualquier tipo de operación, desconectar la tensión de la red.
Prestar atención a no superar el máximo de los vatios indicados en el aparato.

The luminaire shall. Under no circumstance, be covered with insulating matting or similar material.
No cubrir jamás el aparato durante el funcionamiento.

There must be more or less a distance of 50mm between the lateral space of the ole situated in recessed ceiling and the appliance.

Potencia máxima de la bombilla. 1x 75W
Casquillo de la bombilla. GU10
Tipo de bombilla. GU10 
Aparato CLASE II. 

Aparato adecuado para el montaje en superficies normalmente inflamables.
Grado de protección. (IP20 boxed side), (IP44 side glass) IP20/IP44 

The symbol mains the use of self-protection lamps which don't need of any protection scream. 
Distancia mínima de los objetos alum 

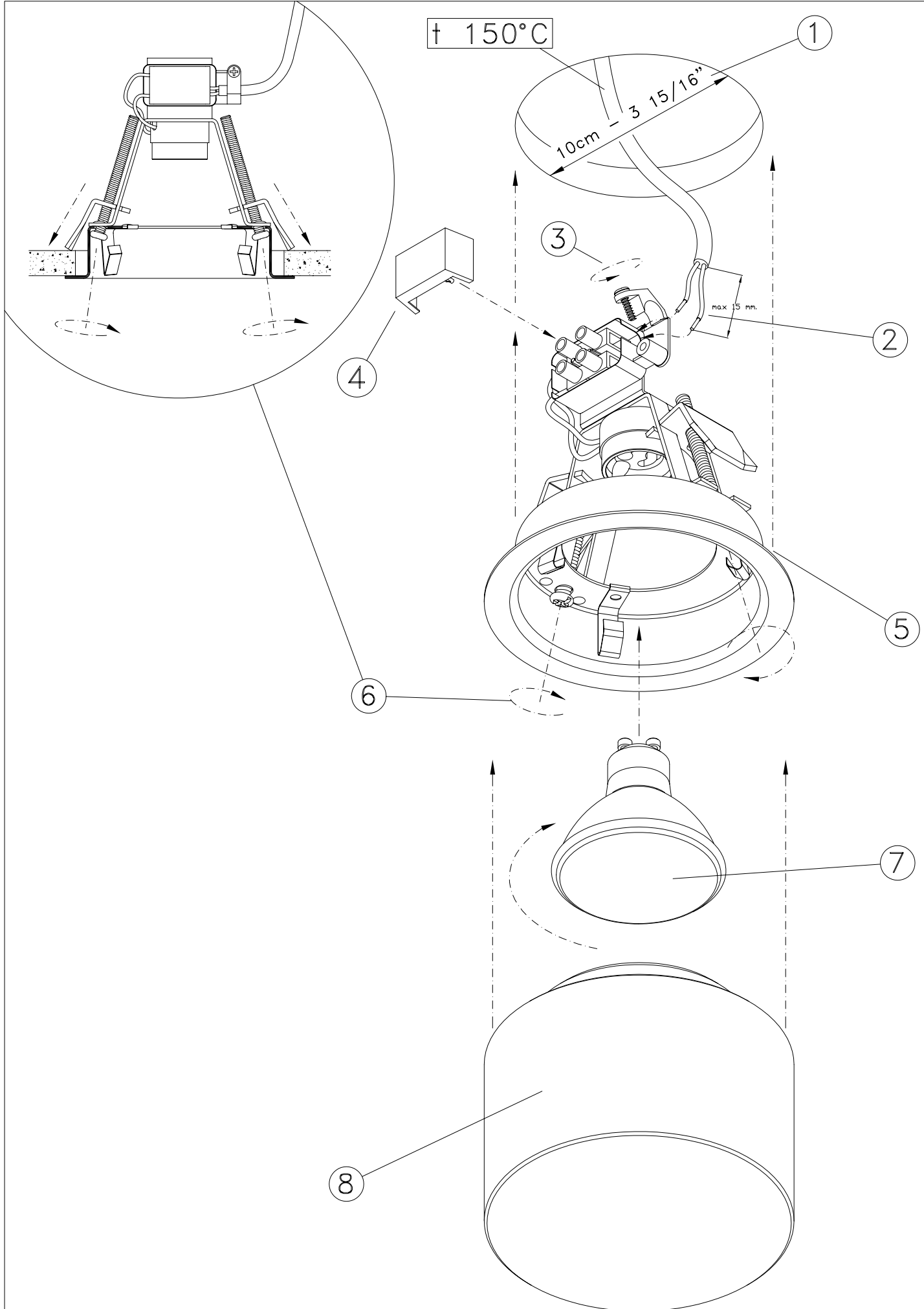

- Procedere al montaggio seguendo le operazioni in ordine numerico progressivo.
- Proceed with assembling following the operations in progressive numerical order.
- Arbeitsgänge in numerischer Ordnung ausführen, um das Gerät zu installieren.
- Il faut procéder a le montage exécutant les opérations par l'ordre numérique progressif.