

# Tools

## F19 F61 15

FE Design

Adjustable semirecessed light with structure in wear-resistant plastic Grivory® material designed to withstand high temperatures, and chromed or powder-painted metal. Design conceived to reduce the time required for installation, assembly and maintenance.

### tipology



### suggested bulb and options (n.i.)

A12702C01

GX8,5  
1x70W  
MR  
40°



### volume - weight

0,012 m<sup>3</sup> - 0,77 Kg

### technical information



### accessories included

### notes

### accessories not included

A40202 Electronic ballast for metal halide lamps 70W (max 1 spot)

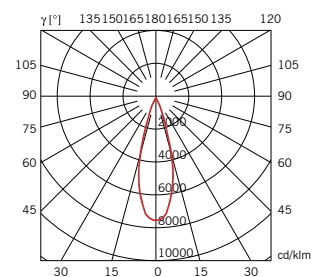
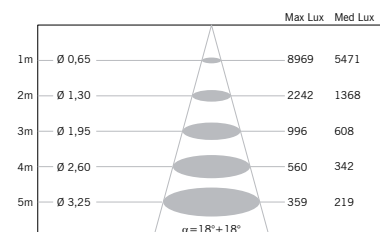
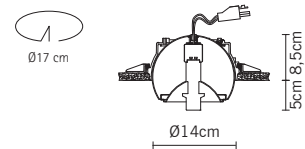

## Tools F19 Montaggio Assembling



Scegliere la dimensione del foro da fare sul cartongesso in base al tipo di cassaforma.

*Determine the size of the hole to be made in the plasterboard, depending on the type of formwork.*



La cassaforma viene fornita già predisposta per lo spessore di 12,5 mm del cartongesso. Per spessori diversi spostare le alette.

*The formwork is supplied ready for a plasterboard thickness of 12.5 mm. For other thicknesses, move the tabs.*



Inserire la cassaforma all'interno del cartongesso e posizionarla in corrispondenza del foro.

*Fit the formwork inside the plasterboard and position it over the hole.*

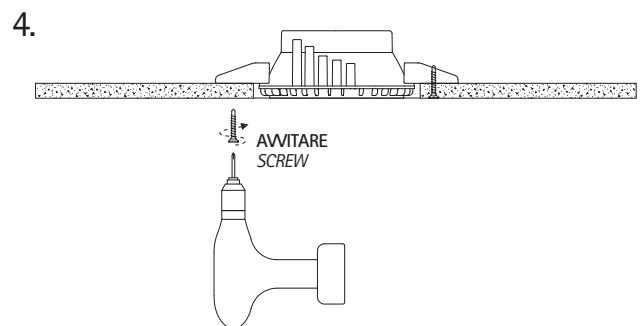

In corrispondenza delle alette, fissare la cassaforma al cartongesso utilizzando i viti incluse nella confezione.

*Where the tabs are, fasten the formwork to the plasterboard using the screws provided in the pack.*



Stuccare perfettamente i bordi della cassaforma in modo da uniformare la finitura del soffitto con l'interno della cassaforma.

*Perfectly plaster the edges of the formwork so the ceiling finish is uniform with the inside of the formwork.*



Nella versione base inserire la lampadina direttamente sulla cassaforma con la molla circolare fornita nella confezione.  
Negli altri casi connettere il porta lampada con la lampadina all'elettrificazione e fissare il tutto ai magneti della cassaforma.

*In the basic version, fit the light bulb directly on the formwork using the round spring provided in the pack.  
In other cases, connect the lamp holder with light bulb to the power supply and fasten the whole to the formwork magnets.*