

Item type

Chandelier

Item name

Vancouver

Item no

113769

Attention! Do not connect your luminaire to electricity until it is fully assembled.

Care instructions:

Wipe with a soft dry cloth, do not use chemicals or abrasive cleaning materials.

Eichholtz B.V.

Delfweg 52
2211 VN Noordwijkerhout
The Netherlands

🏠 www.eichholtz.com
✉ service@eichholtz.com
☎ +31 (0)252 515 850

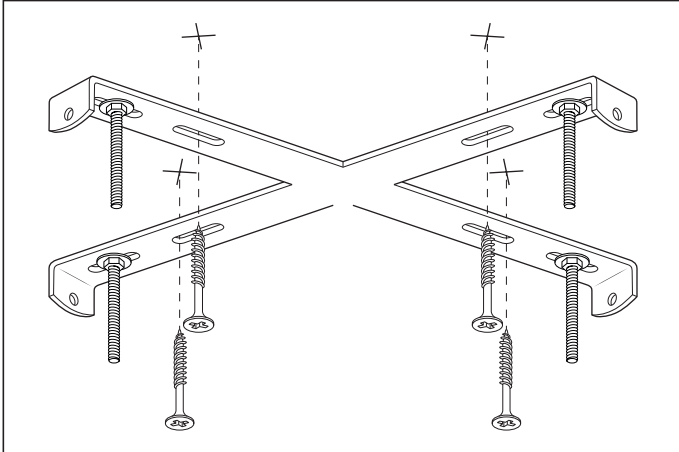

1. Fix the crossbar to the ceiling by using mounting plugs and screws suitable to your ceiling type. Place or hold the lamp in an elevated position in such a way that the wires can freely reach the ceiling junction box.

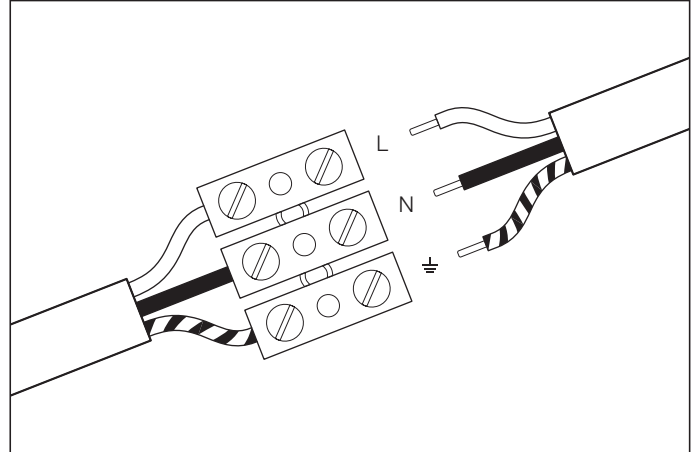

2. Connect the 3 wires to the LED driver according to their colours. Brown is the live wire, blue is the neutral wire, green/yellow is the earth wire. The LED driver is suitable to be used in combination with a LED dimmer (not included).

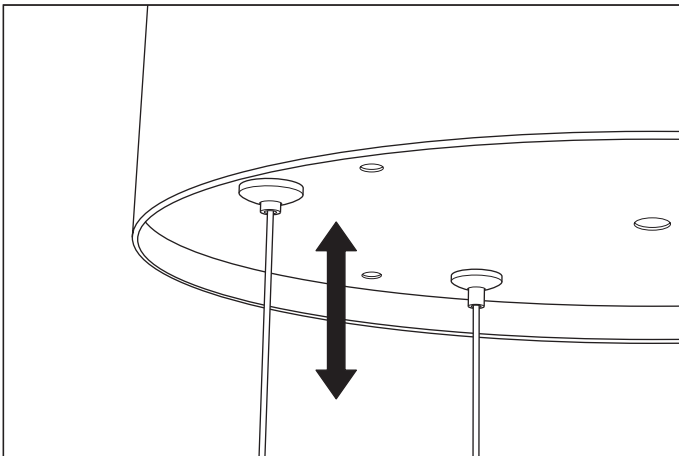

3. Adjust the height of the steel wires by pressing the wire lock on the ceiling canopy and pulling/pushing the wire through.

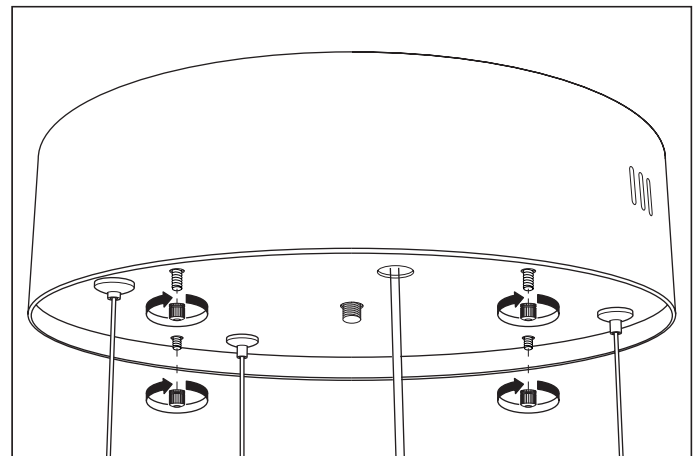

5. Place the ceiling canopy over the crossbar. Fix the ceiling canopy securely with the nuts.

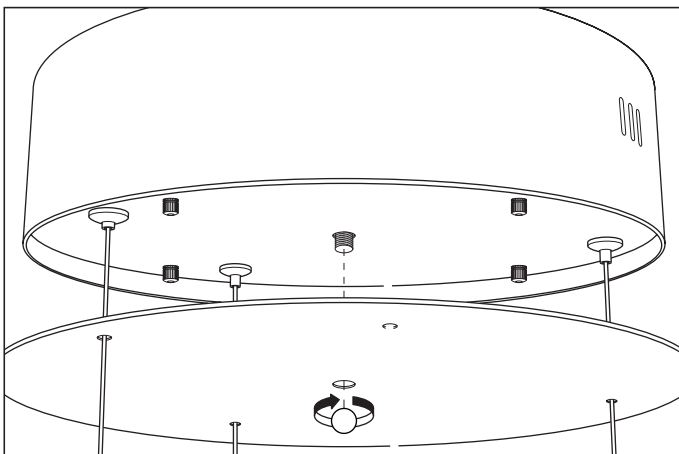

6. Place the ceiling plate over the canopy. Fix the ceiling canopy securely with the nut.