

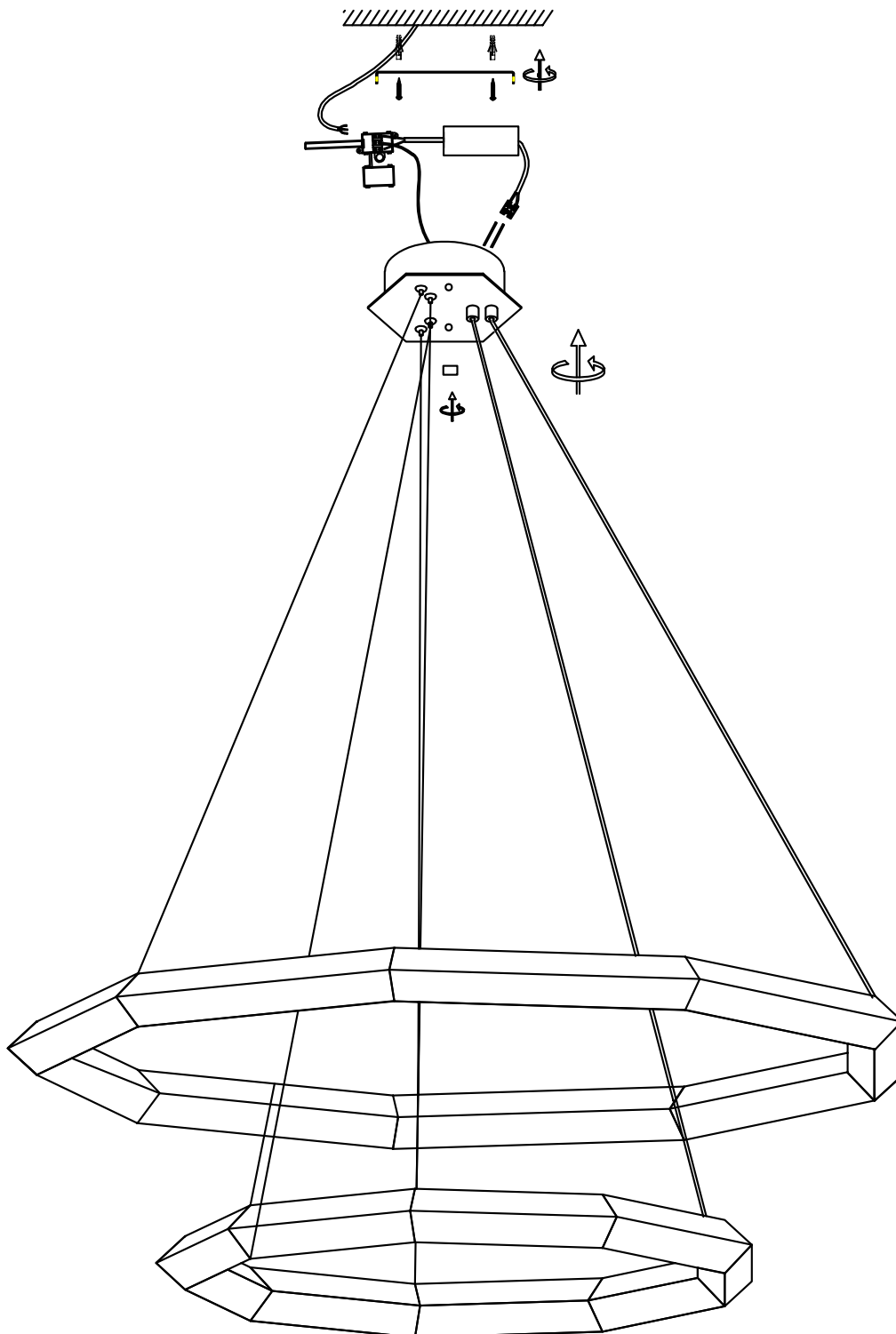

E I C H H O L T Z

113469 CHANDELIER HELVETIA

ASSEMBLY INSTRUCTION



Fix the crossbar to the ceiling by using mounting plugs and screws suitable to your ceiling type.

Place or hold the lamp in an elevated position in such a way that the wires can freely reach the ceiling junction box.

Connect the 3 power wires to the wire connector according to their colours. Brown is the live wire, blue is the neutral wire, green/yellow is the earth wire. The LED driver is suitable to be used in combination with a LED dimmer (not included).

Adjust the height of the steel wires by pressing the wire lock on the ceiling canopy and pulling/pushing the wire through.

Adjust the height of the electric wires by pulling them through the wire nuts and fix each wire in the correct position with the screw on the side.