



E I C H H O L T Z

113050 WALL LAMP SENSO

ASSEMBLY INSTRUCTION

PARTS

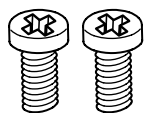

SCREWS

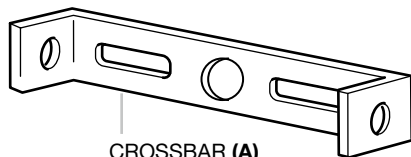

CROSSBAR (A)



SCREW COVER

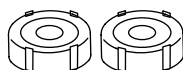

SCREW PLASTICS

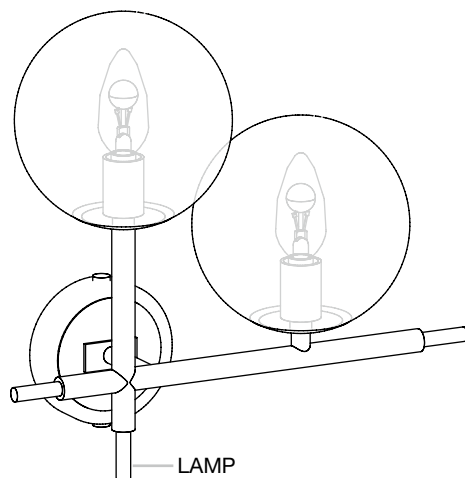

LAMP

1

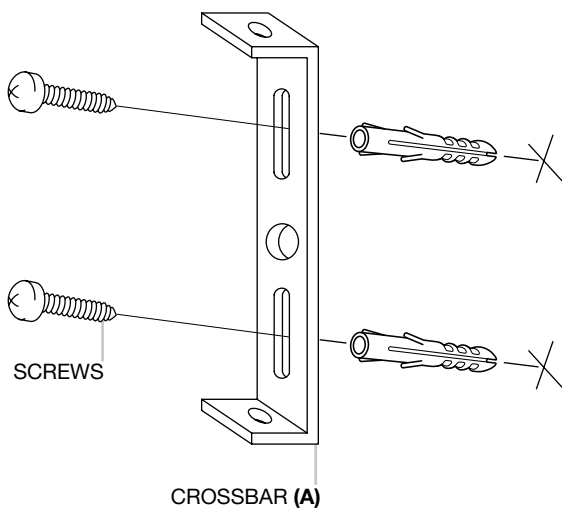

SCREWS

CROSSBAR (A)

2

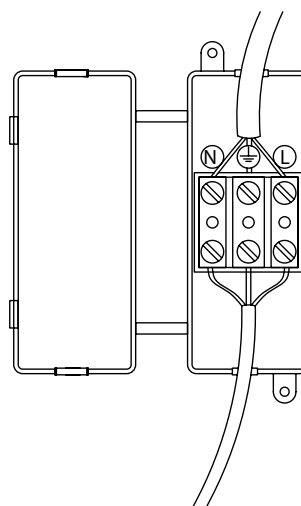

3

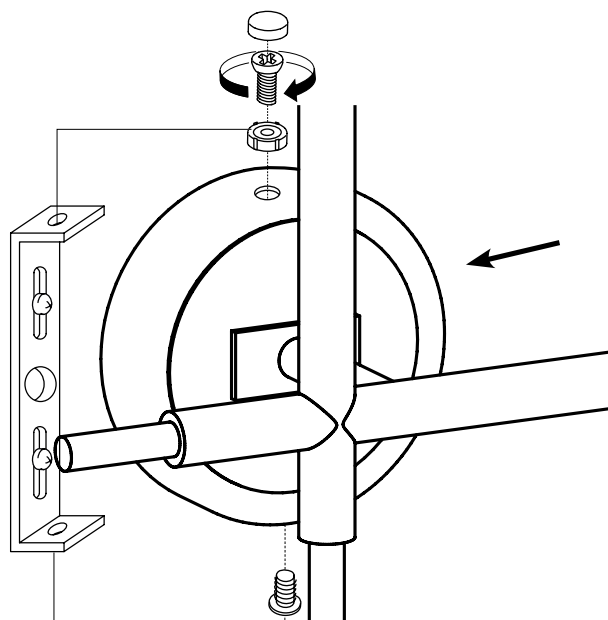

Switch off the power at the main switchboard.

Fix the crossbar to the wall by using wall mounting plugs and screws suitable to your wall type.

Connect the 3 power wires according to their colours. Brown is the live wire, blue is the neutral wire, the green yellow wire is the earthwire.

Place the lamp over the cross bar and put the screws through the plastic rings. Tighten the screws gently. Place the screw covers.

Place the bulbs to the lampholders.

Screw the glass balls on to the lamp.