



E I C H H O L T Z

111826 CHANDELIER BERMUDE

ASSEMBLY INSTRUCTION

1 Install a suitable hanger rod with ceiling plate to the lamp body.

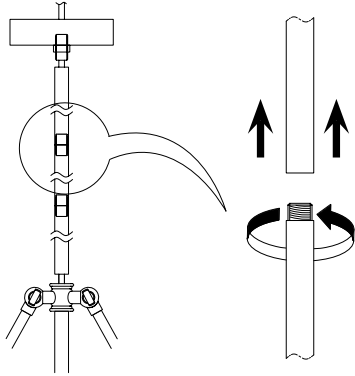

2 Place the middle rod upright and fix the three pipes with the wing nuts on top and bottom side.

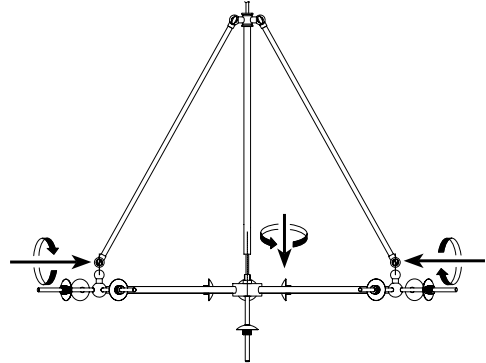

3 Thread the wire from the lamp through the pipe.

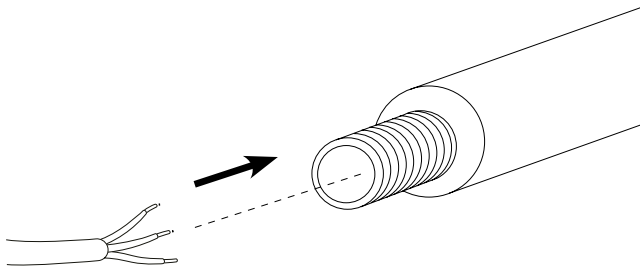

4 Fix the ceiling plate (A) to the ceiling by using mounting plugs and screws suitable to your ceiling type. Guide the wires through the plate. Place or hold the lamp in an elevated position in such a way that the wires can freely reach the ceiling junction box.

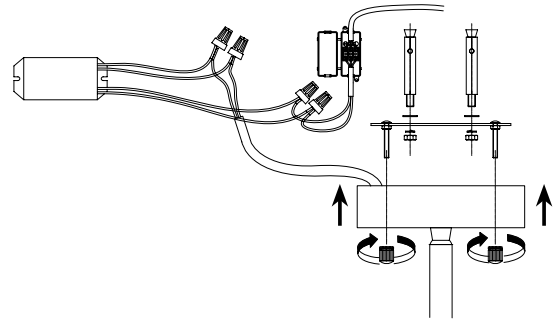

5 Connect the 3 power wires with the transformer according to their colours. Brown is the live wire, blue is the neutral wire, green/yellow is the earth wire. Place the ceiling canopy flush against the ceiling and fix it securely with the two nuts supplied.

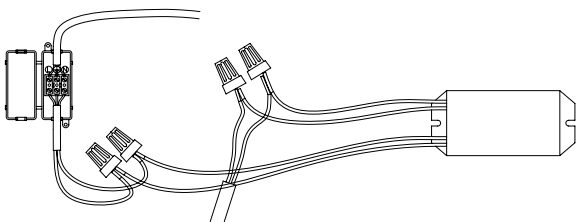

6 Adjust the arms until your luminaire is balanced. Place the G4 lightbulbs (included) and carefully screw on the glass balls.

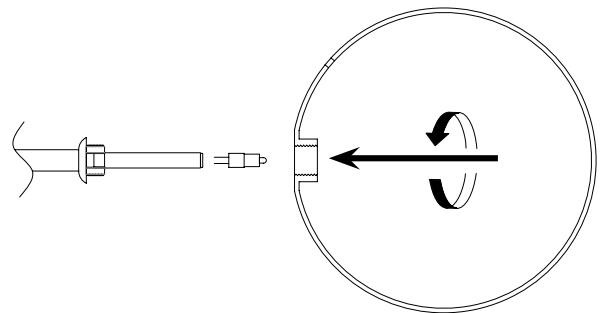

Turn-off the electricity supply at main circuit panel before installing.
Do not connect electricity supply until your ceiling light is fully assembled and installed.

CARE INSTRUCTION

Wipe clean with soft, dry cloth.
Always avoid the use of harsh chemicals or abrasive cleaners as they may cause damage to the fixture's finish.

FINAL

