

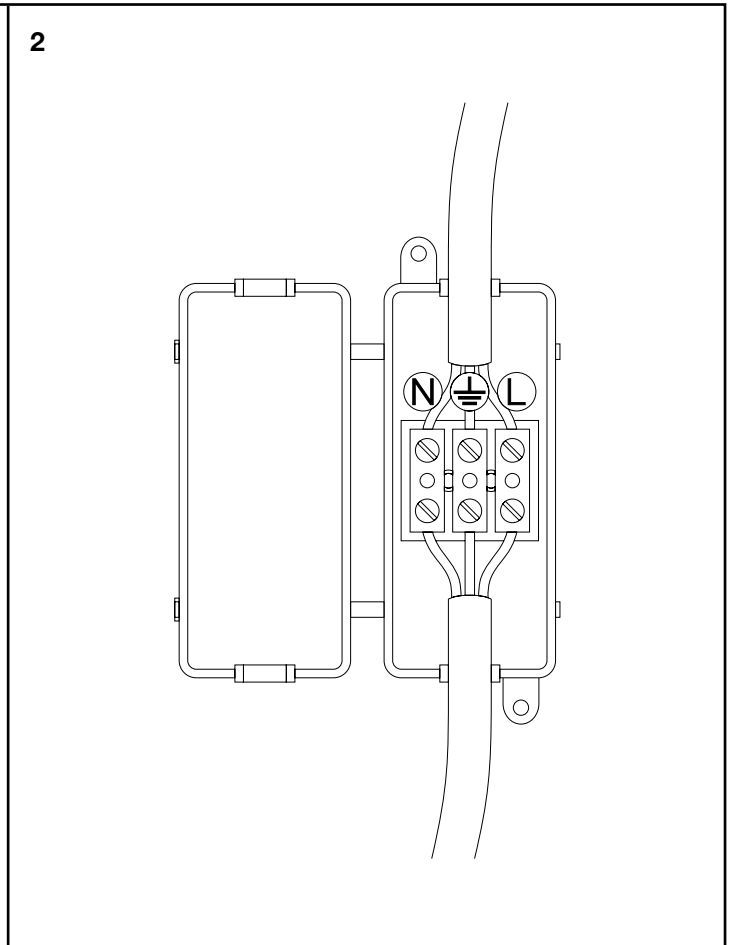

E I C H H O L T Z

111592 CHANDELIER PASADENA

ASSEMBLY INSTRUCTION

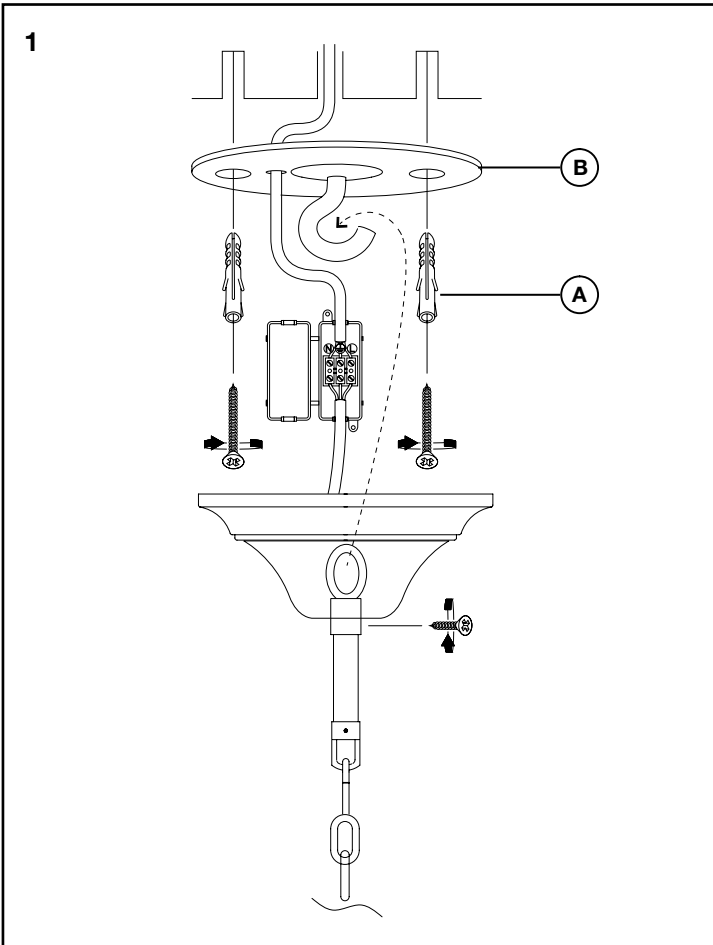

Turn off the electricity supply at the main circuit panel before installing.  
Do not connect the electricity supply until your luminaire is fully assembled and installed.

Fix the ceiling plate (B) to the ceiling by using mounting plugs and screws (A) suitable to your ceiling type. Make sure to lead the wire through the plate.

Hang the chandelier on the hook of the ceiling plate with the canopy (B) at the lowest position. Carefully lower the lamp until the chain is taut. Straighten the chain links.

Connect the 3 power wires according to their colours. Brown is the live wire, blue is the neutral wire, green/yellow is the earth wire.  
Move the canopy up until it is flush with the ceiling, tighten it with the allen screw on the side (F).

Place the bulbs and finally place the glass tubes.

