



E I C H H O L T Z

111528 WALL LAMP AVONDALE

ASSEMBLY INSTRUCTION

- 1** Turn off the electricity supply at the main circuit panel before installing. Do not connect the electricity supply until your luminaire is fully assembled and installed. Fix the crossbar (A) to the wall by using wall mounting plugs and screws suitable to your wall type.

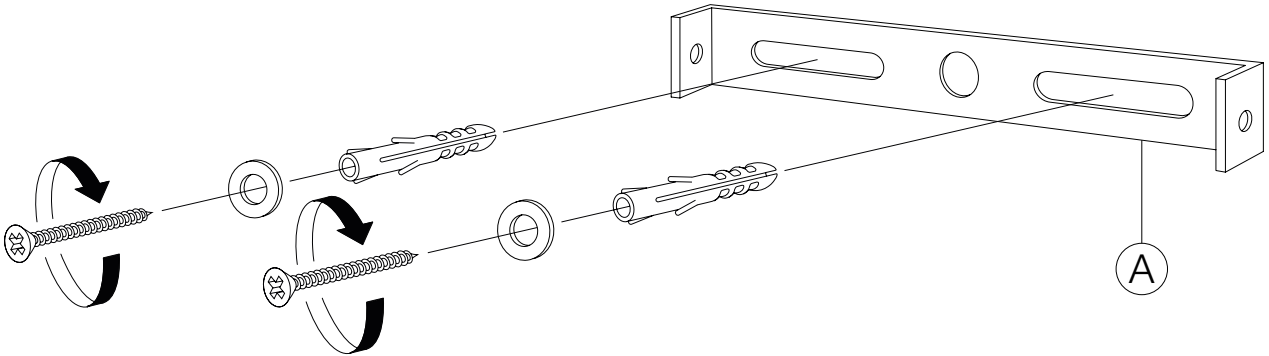

- 2** Connect the 3 wires according to their colours. Brown is the live wire, blue is the neutral wire, green/yellow is the earth wire.

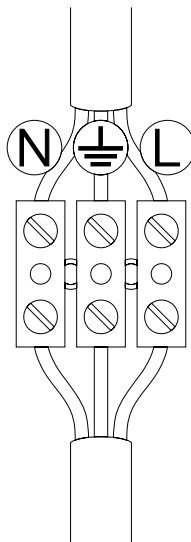

- 3** Place the lamp over the cross bar and fix it securely with the screws supplied.

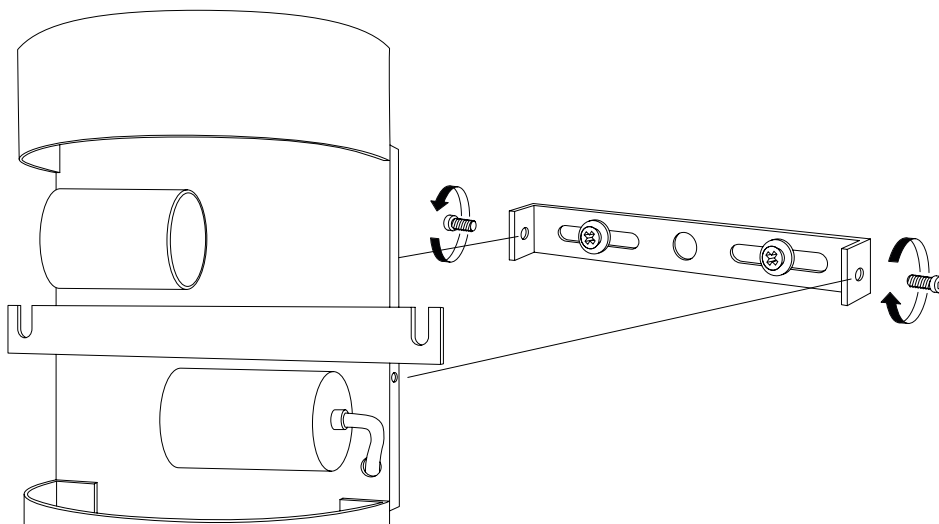



E I C H H O L T Z

111528 WALL LAMP AVONDALE

ASSEMBLY INSTRUCTION

4 Place the bulbs and place the frontcover.

