

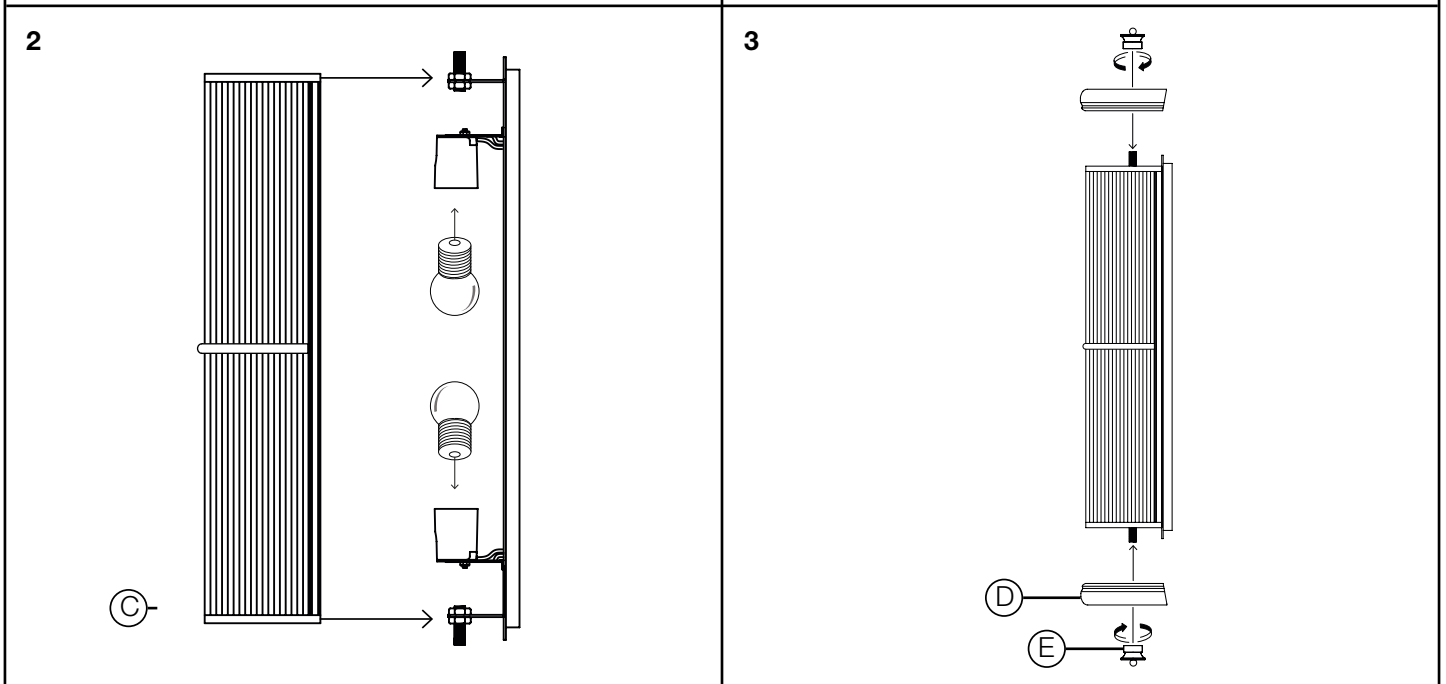

E I C H H O L T Z

111521 WALL LAMP GLORIOUS (H. 52 CM)

ASSEMBLY INSTRUCTION

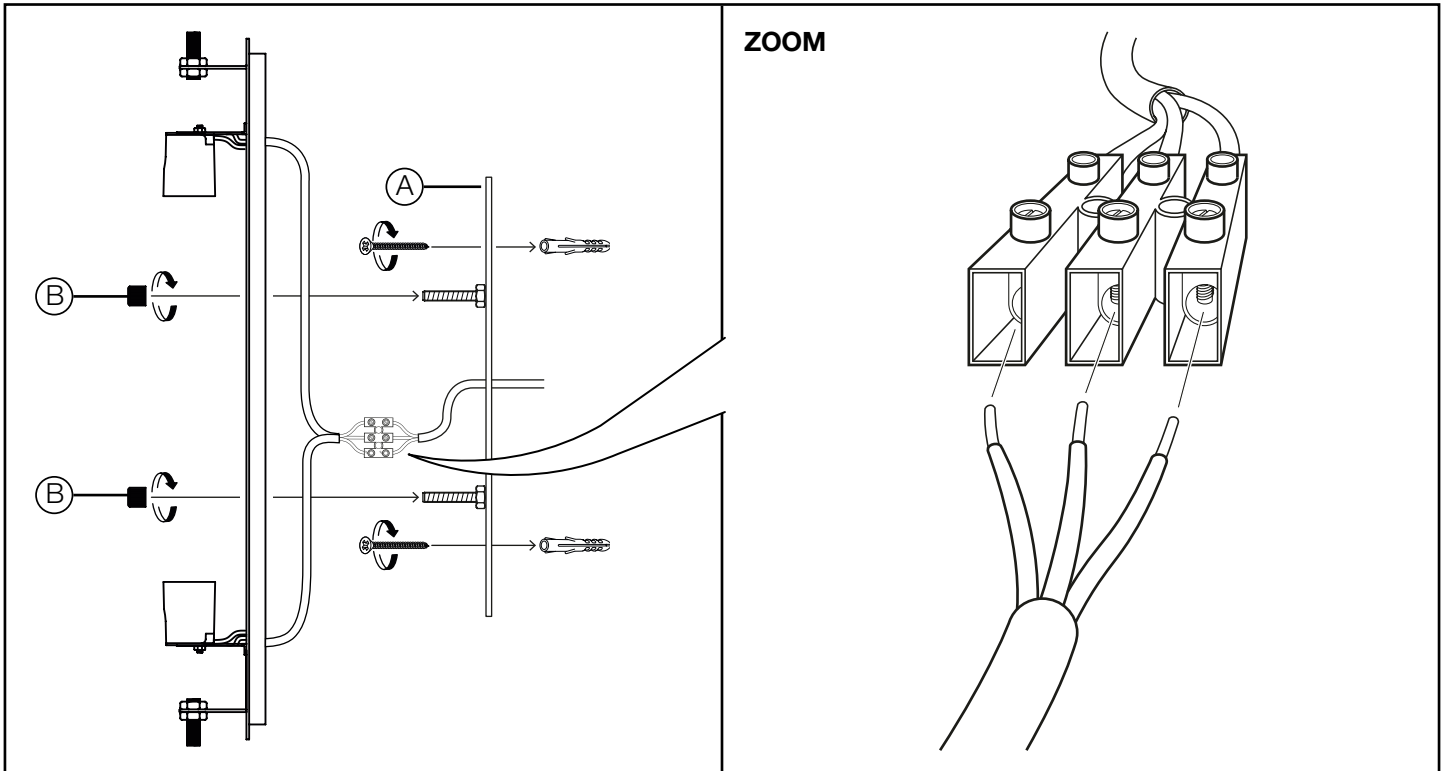

Turn off the electricity supply at the main circuit panel before installing. Do not connect the electricity supply until your luminaire is fully assembled and installed.

Fix the crossbar (A) to the wall by using wall mounting plugs and screws suitable to your wall type.  
Connect the 3 wires according to their colours. Brown is the live wire, blue is the neutral wire, green/yellow is the earth wire.  
Place the lamp over the cross bar and fix it securely with the nuts (B) supplied.

Place the cover (C) over the lamp and secure it by first placing the bottom cap (D) and securing it with the finial (E). Finally place the top cap and secure the it with the finial.

**CARE INSTRUCTION**

Wipe clean with soft, dry cloth.  
Always avoid the use of harsh chemicals or abrasive cleaners as they may cause damage to the fixture's finish.