



E I C H H O L T Z

111383 WALL LAMP BRUNSWICK

ASSEMBLY INSTRUCTION

PARTS

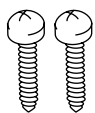

SCREWS

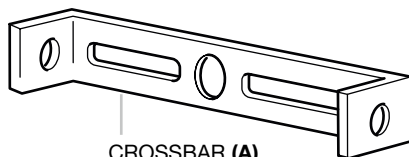

CROSSBAR (A)



ALLEN SCREWS



ALLEN KEY

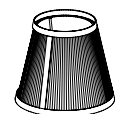

LAMP

1

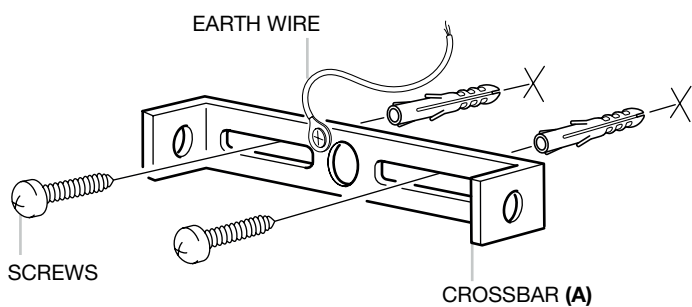

EARTH WIRE

SCREWS

CROSSBAR (A)

2

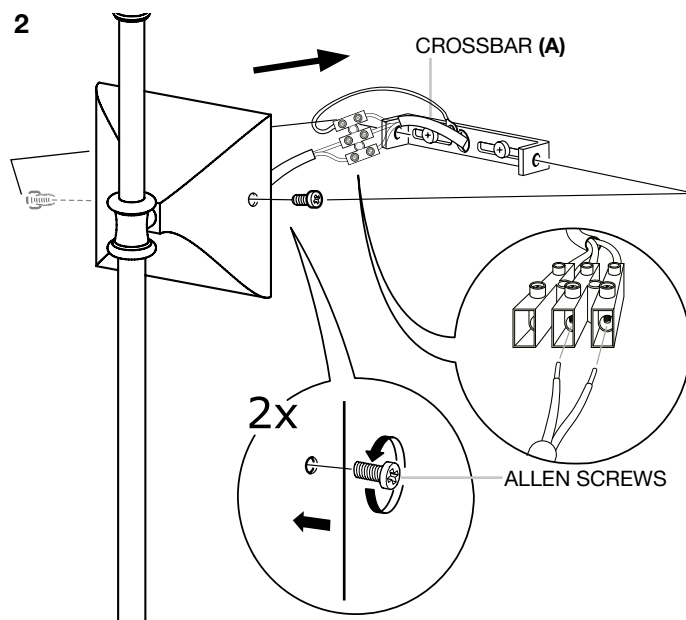

CROSSBAR (A)

2x

ALLEN SCREWS

Turn off the electricity supply at the main circuit panel before installing.
Do not connect the electricity supply until your luminaire is fully assembled and installed.

Fix the crossbar (A) to the wall by using wall mounting plugs and screws suitable to your wall type.

Connect the 3 power wires according to their colours. Brown is the live wire, blue is the neutral wire, the green/yellow wire is the earthwire.
Place the lamp over the cross bar and fix it securely with the allen screws.

CARE INSTRUCTION

Wipe clean with soft, dry cloth.
Always avoid the use of harsh chemicals or abrasive cleaners as they may cause damage to the fixture's finish.