



E I C H H O L T Z

111047 WALL LAMP CRAWLEY

ASSEMBLY INSTRUCTION

1

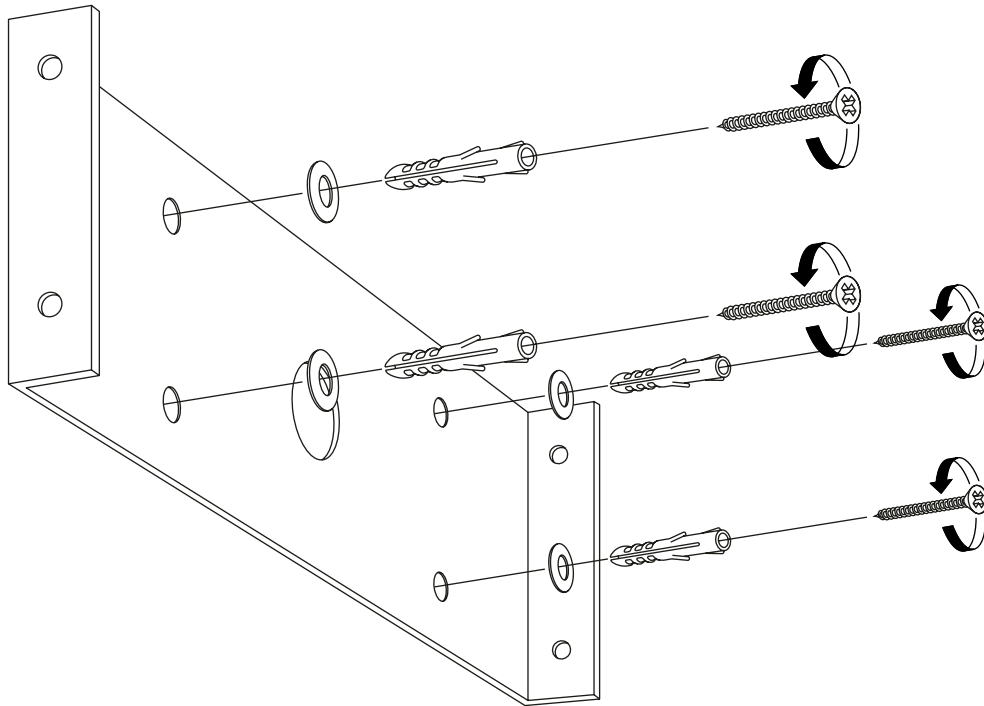

2

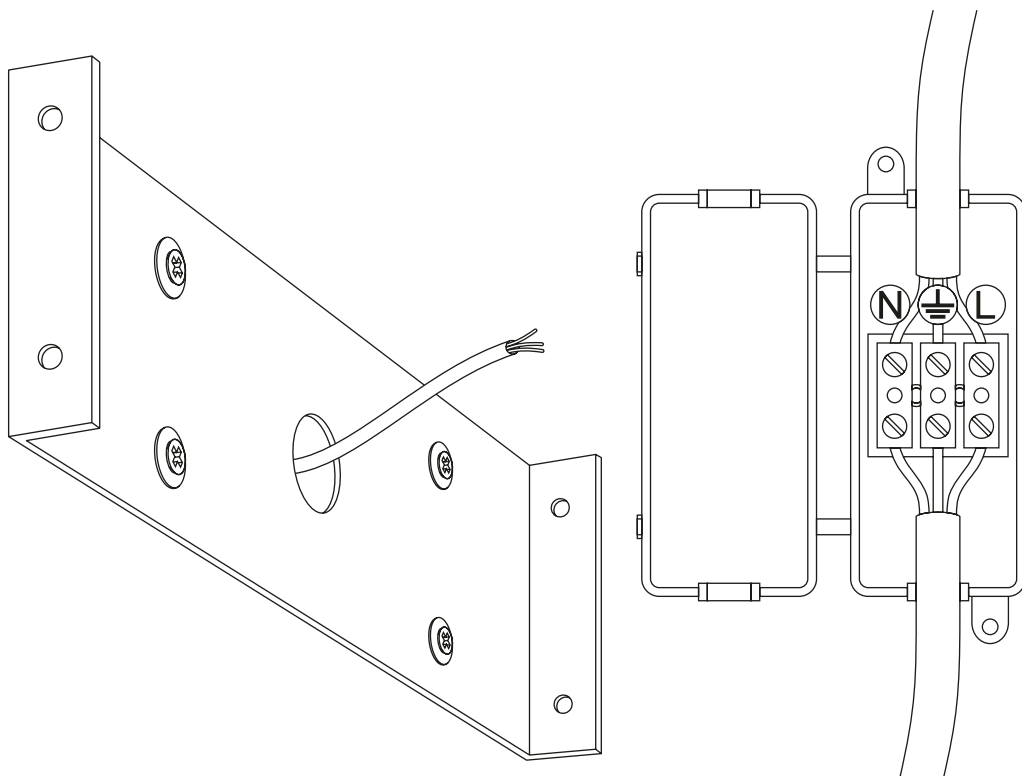



E I C H H O L T Z

111047 WALL LAMP CRAWLEY

ASSEMBLY INSTRUCTION

3

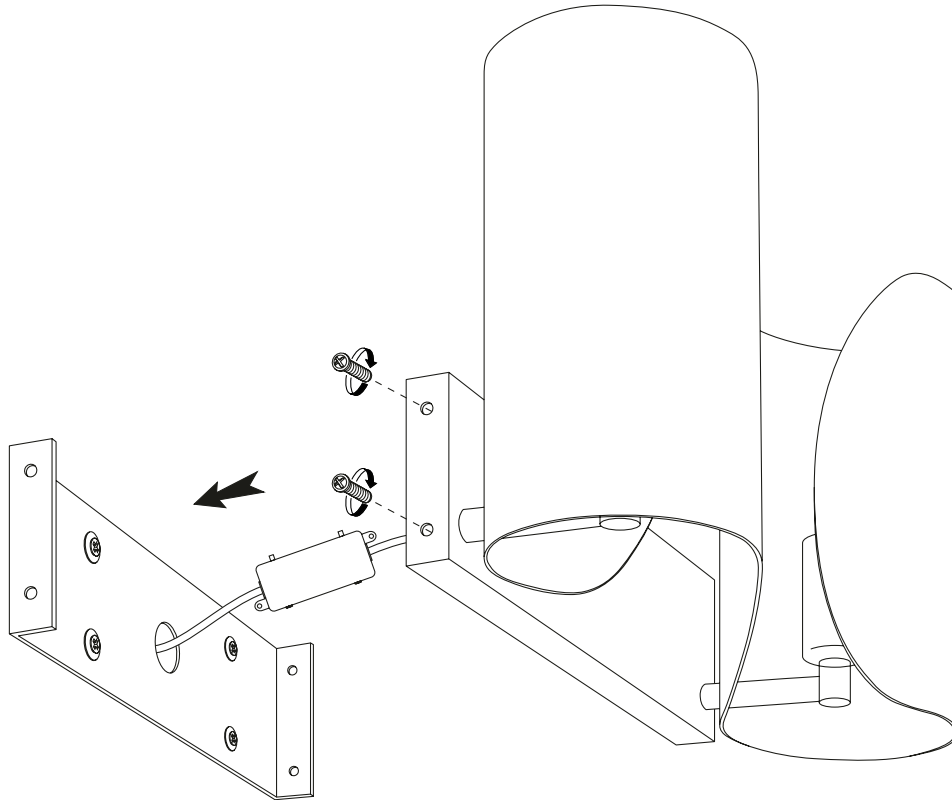

4

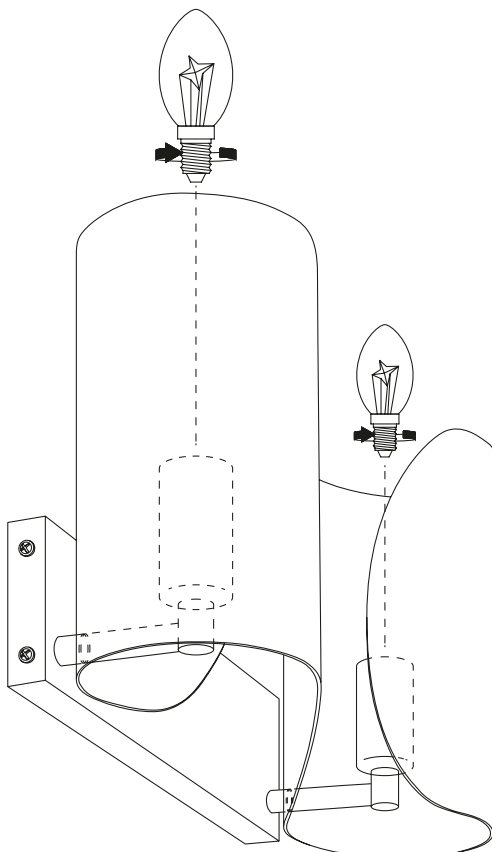

Turn off the electricity supply at the main circuit panel before installing.
Do not connect the electricity supply until your luminaire is fully assembled and installed.

Fix the wall plate to the wall by using wall mounting plugs and screws suitable to your wall type.

Connect the 3 wires according to their colours. Brown is the live wire, blue is the neutral wire, green/yellow is the earth wire.

Place the lamp over the wall plate and fix it securely with the screws supplied.

Place the bulbs.