



E I C H H O L T Z

110901 TABLE LAMP PIMLICO

ASSEMBLY INSTRUCTION

1

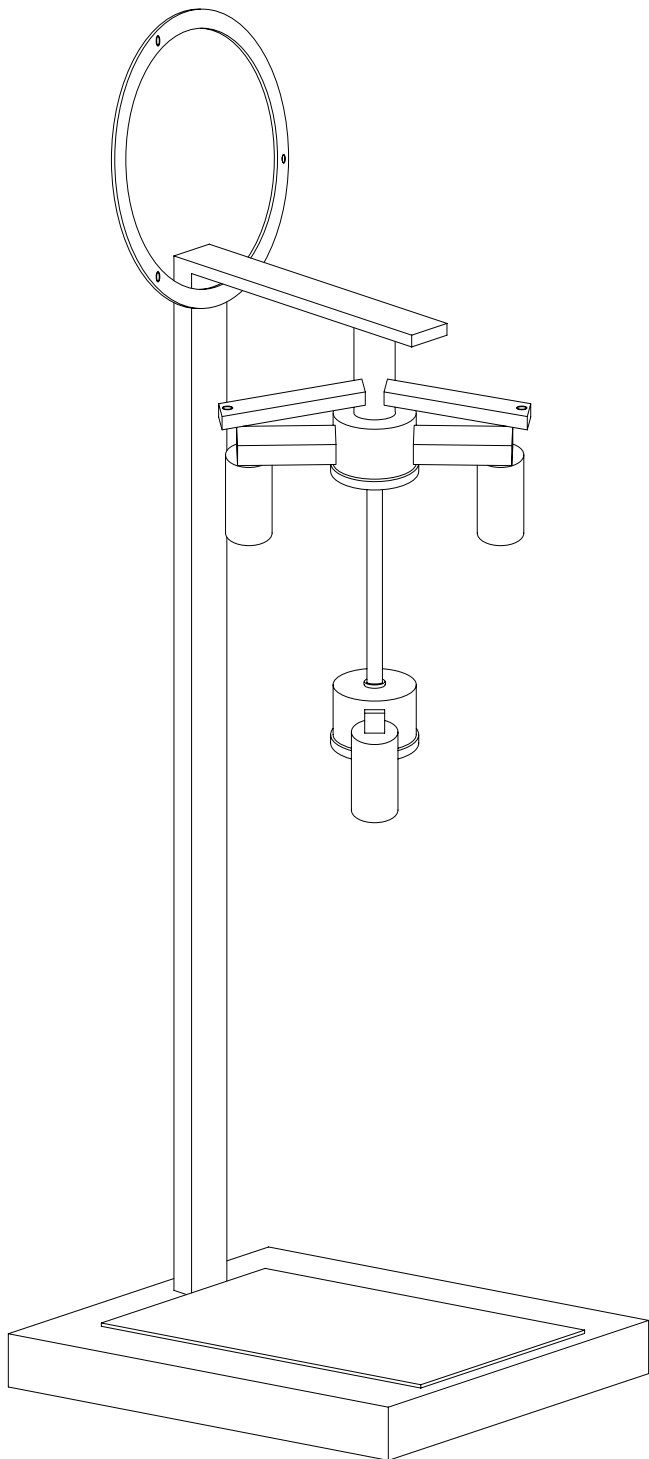

Move the ring to the top of the frame and hold it there.

2

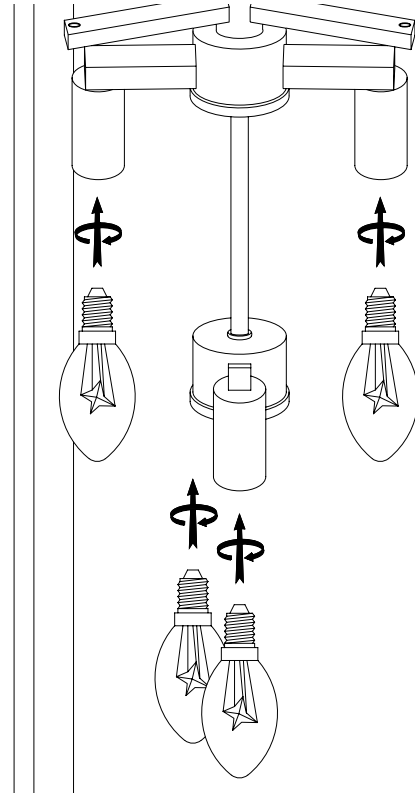

Place the light bulbs.

3

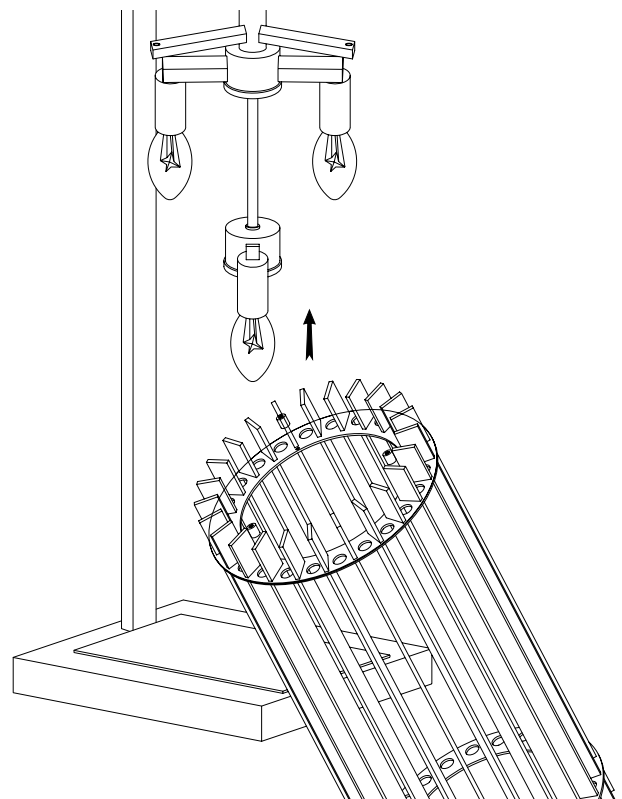

Place the shade with glass rods over the bulbs. 1/2



E I C H H O L T Z

110901 TABLE LAMP PIMLICO

ASSEMBLY INSTRUCTION

4

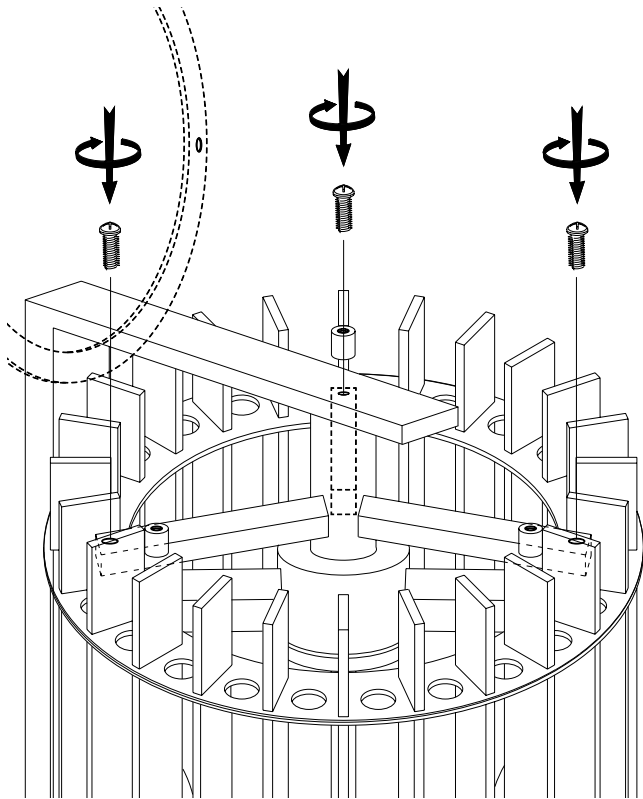

Fix the shade to the frame with 3 screws.

5

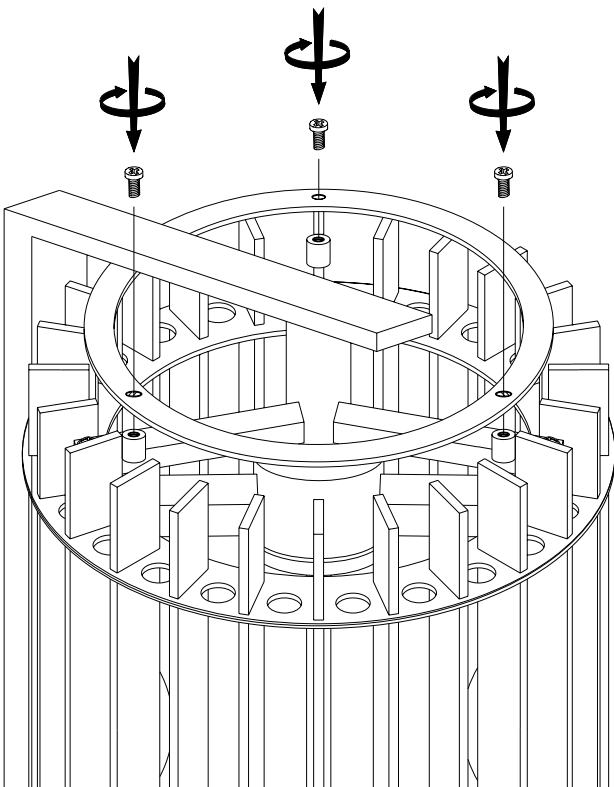

Fix the ring to the shade.

6

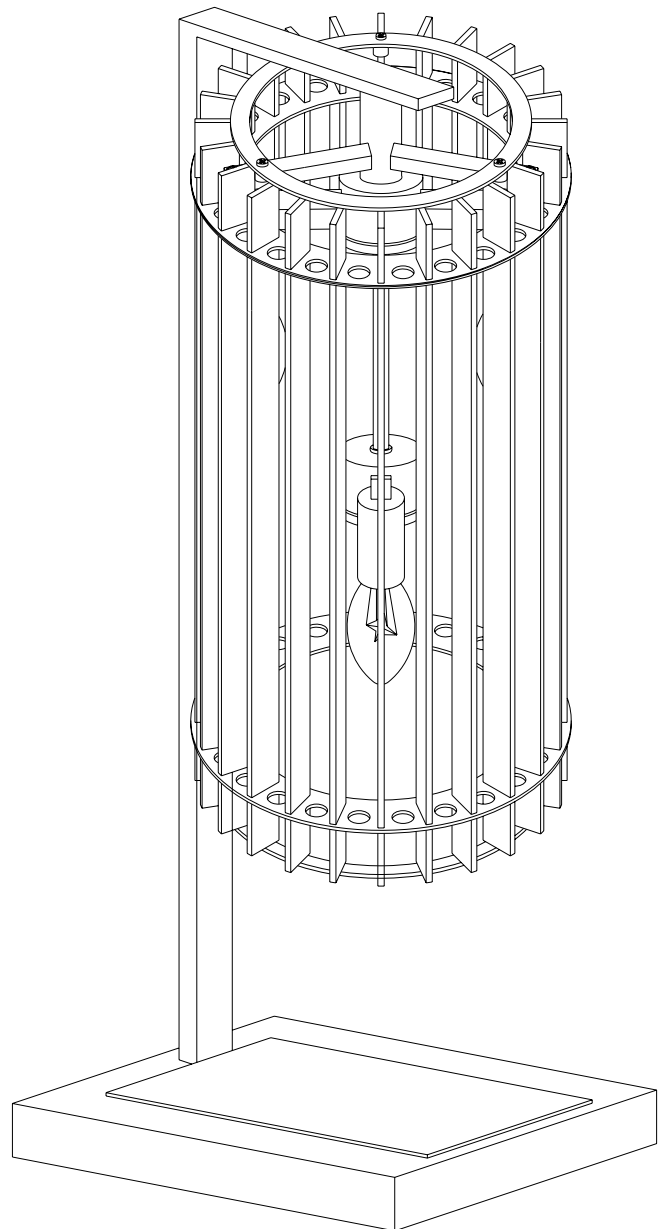

Final product.

2/2