

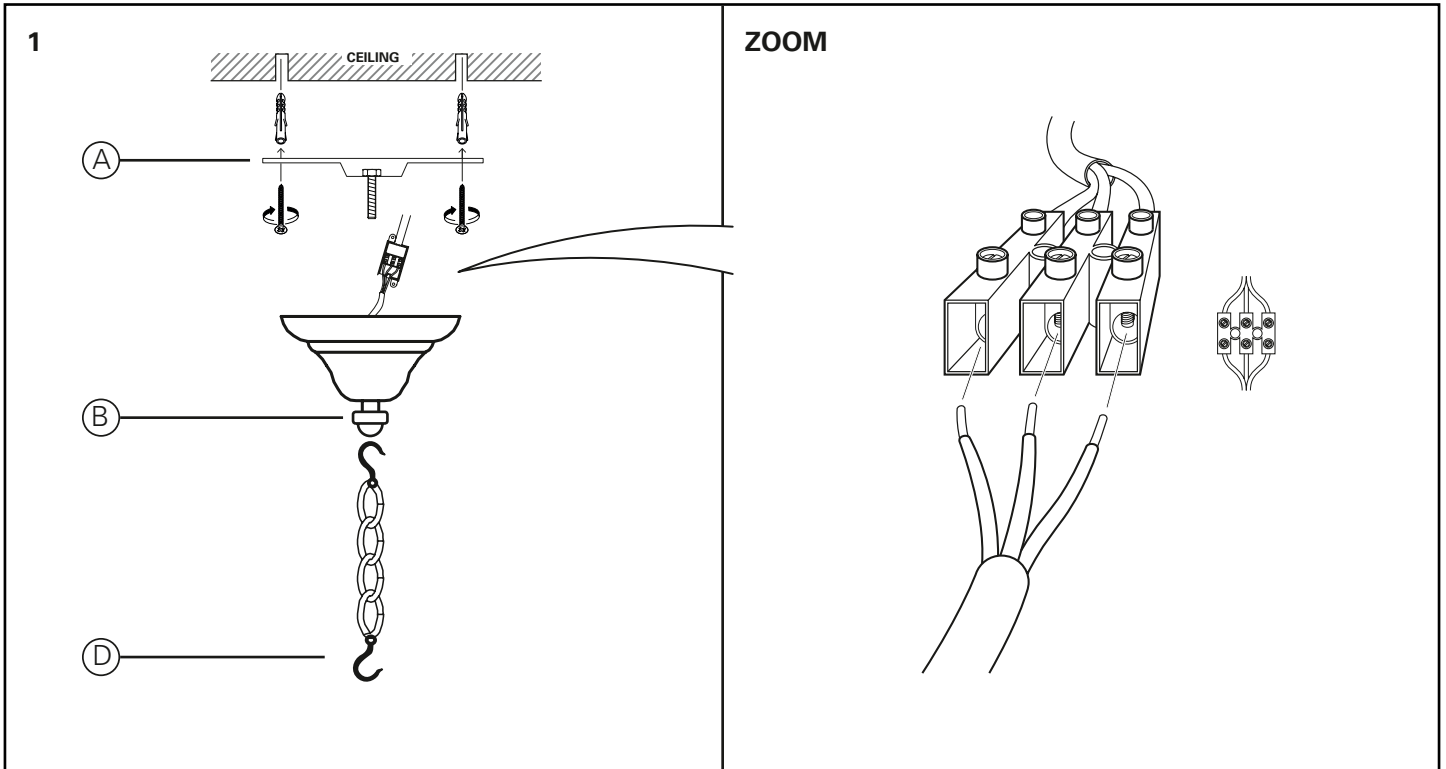

E I C H H O L T Z

109233 LANTERN CAMERON S

ASSEMBLY INSTRUCTION



TWO PEOPLE ARE REQUIRED FOR SAFE MOUNTING OF THIS LUMINAIRE

1. Carefully unpack all fixture parts and hardware from the carton and check material thoroughly before disposing of box and packing.
2. Turn off the electricity supply at the main circuit panel before installing. Do not connect the electricity supply until your luminaire is fully assembled and installed.
3. Fix the ceiling bracket (A) to the ceiling by using mounting plugs and screws suitable to your ceiling type.
4. Place or hold the lamp in an elevated position in such a way that the wires can freely reach the ceiling junction box. Thread the wires through the components (suspension eye, retaining nut, ceiling canopy) and connect the 3 power wires according to their colours. Brown is the live wire, blue is the neutral wire, green/yellow is the earth wire. Tighten the retaining nut (B).
5. Hang the lamp holder hub (C) from the chain hook (D) and then hang the Rods (E) with the four hooks at the top of holder hub.
6. Put glass (F) into the ring (G) and hang it up on all rods with the four hooks on ring.
7. Adjust the spider (H) at the level of ring (G) and tighten the nut with pliers to ensure the spider will stay in the right position. It will stop the movement of holder hub and prevent the glass from breakage.

