

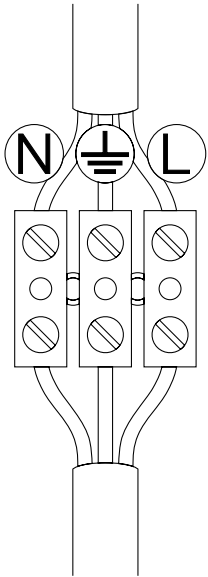
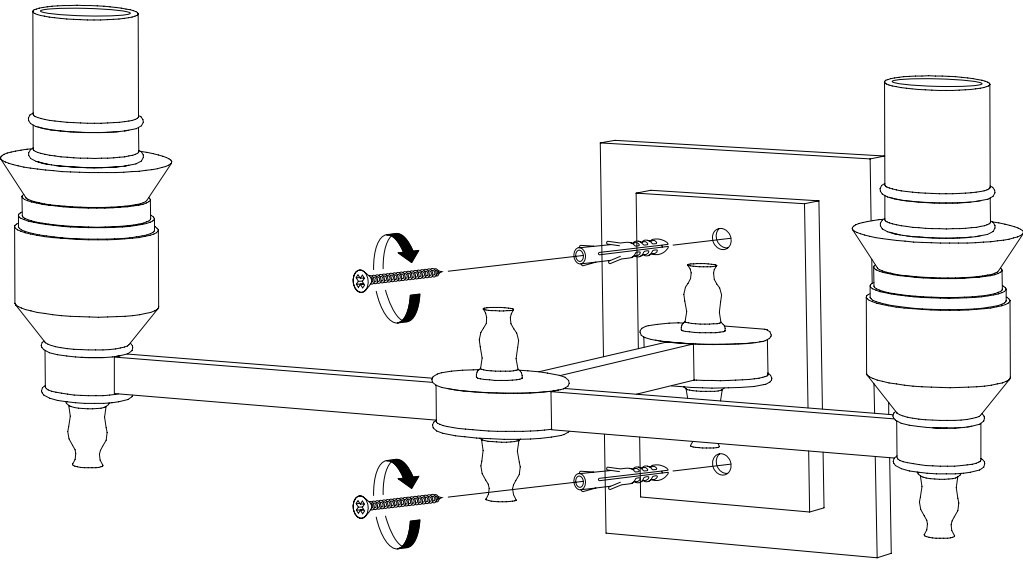
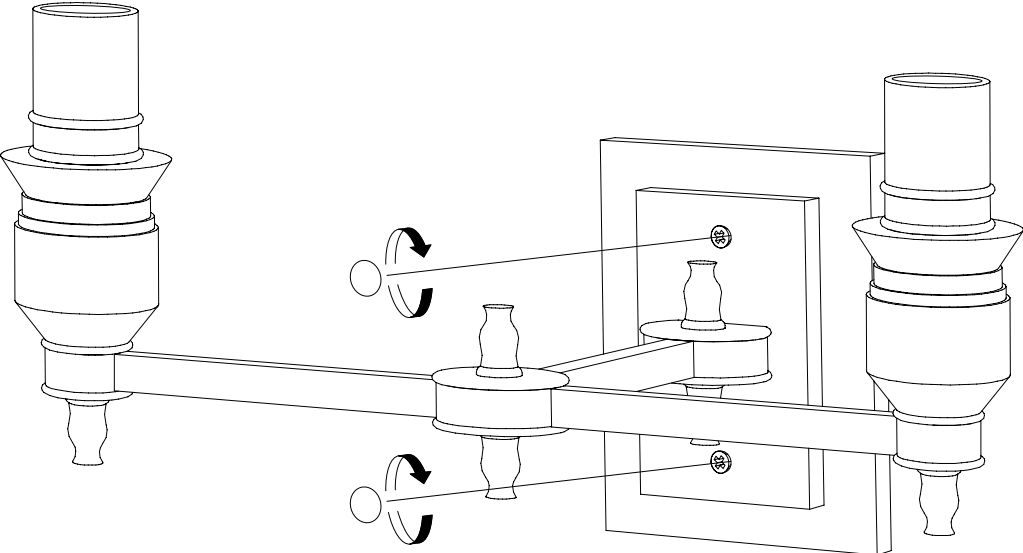

E I C H H O L T Z

108635 WALL LAMP LEXINGTON DOUBLE

ASSEMBLY INSTRUCTION

<p>1</p> 	<p>Turn off the electricity supply at the main circuit panel before installing. Do not connect the electricity supply until your luminaire is fully assembled and installed.</p> <p>Connect the 3 wires according to their colours. Brown is the live wire, blue is the neutral wire, green/yellow is the earth wire.</p> <p>Fix the luminaire to your junction box or wall by using suitable wall mounting plugs and screws.</p> <p>Screw the covers on the screw heads.</p>
<p>2</p> 	
<p>3</p> 	



E I C H H O L T Z

108635 WALL LAMP LEXINGTON DOUBLE

ASSEMBLY INSTRUCTION

4

