



E I C H H O L T Z

108632 WALL LAMP LEXINGTON SWING

ASSEMBLY INSTRUCTION

1

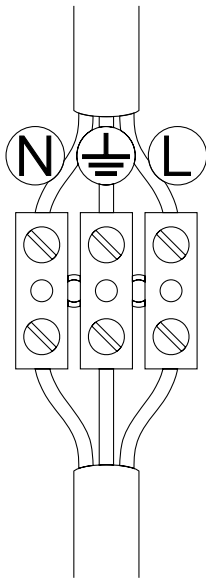

Turn off the electricity supply at the main circuit panel before installing.
Do not connect the electricity supply until your luminaire is fully assembled and installed.

Connect the 3 wires according to their colours. Brown is the live wire, blue is the neutral wire, green/yellow is the earth wire.

Fix the luminaire to your junction box or wall by using suitable wall mounting plugs and screws.

Screw the covers on the screw heads.

2

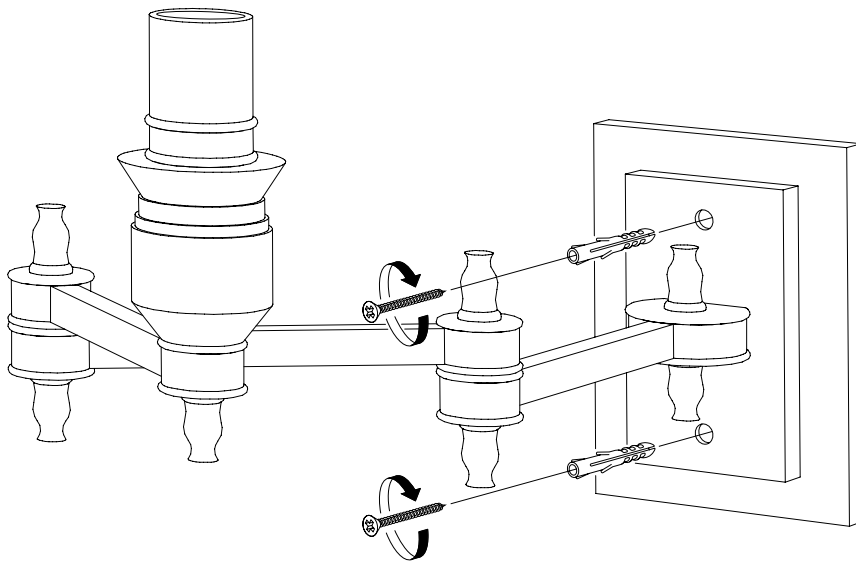

3

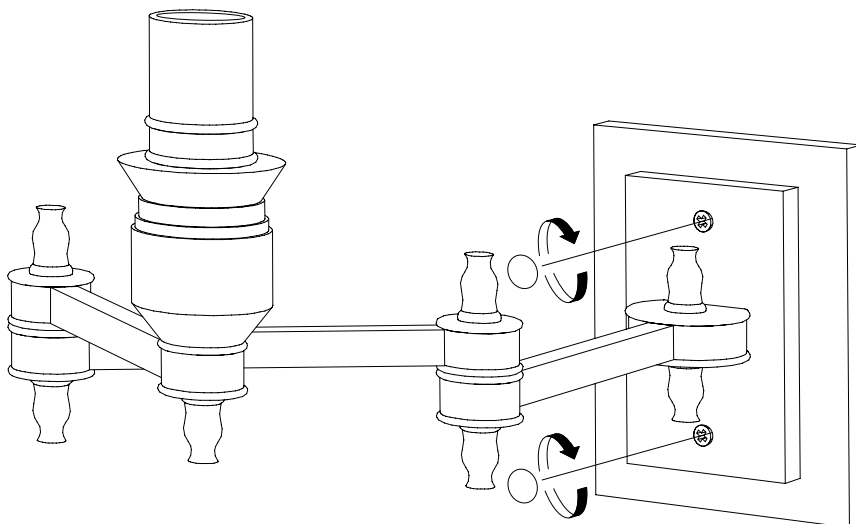



E I C H H O L T Z

108632 WALL LAMP LEXINGTON SWING

ASSEMBLY INSTRUCTION

4

