



E I C H H O L T Z

106859 LAMP HARPERS L

ASSEMBLY INSTRUCTION

- 1 Remove the lamp and the carton with the glass from the outer carton.

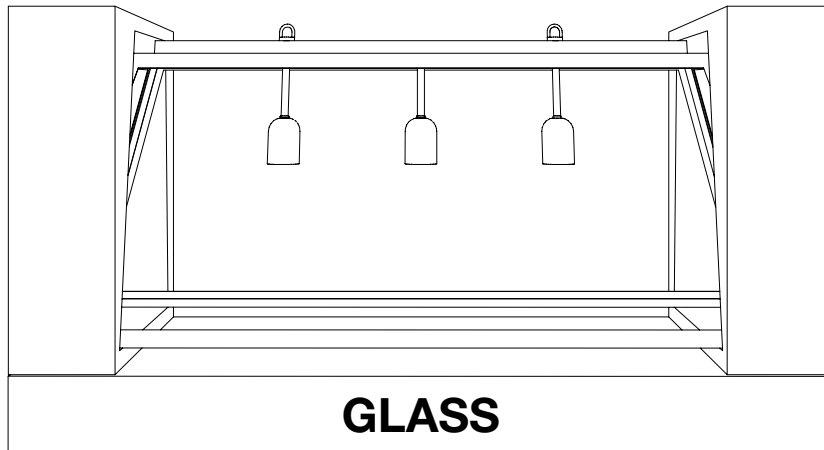

- 2 Unpack the glass carefully.

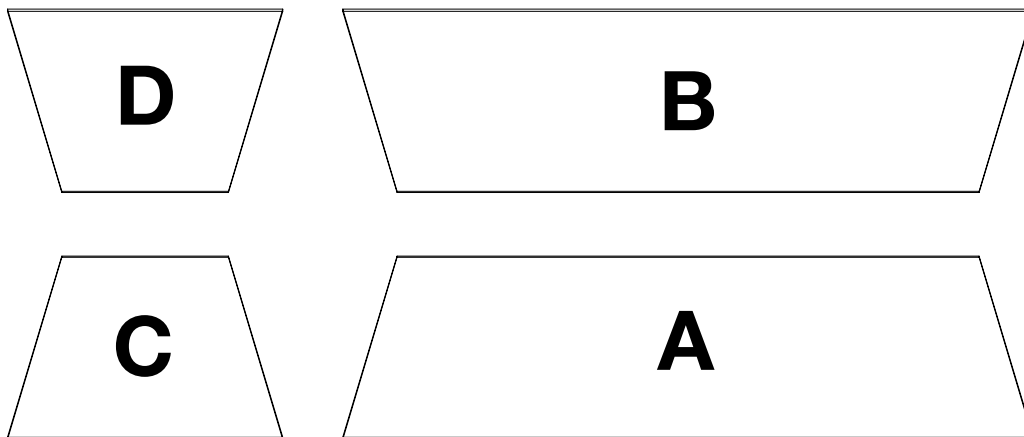

- 3 Place the lamp on its back, so the side for glass A is on the floor or table. Now slide glass A between the clips and close the clips. Follow the same steps for glass B, C and D.

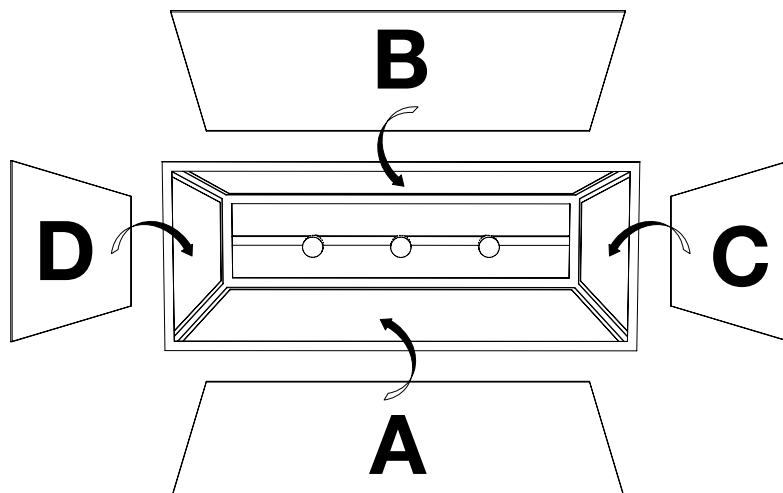



E I C H H O L T Z

106859 LAMP HARPERS L

ASSEMBLY INSTRUCTION

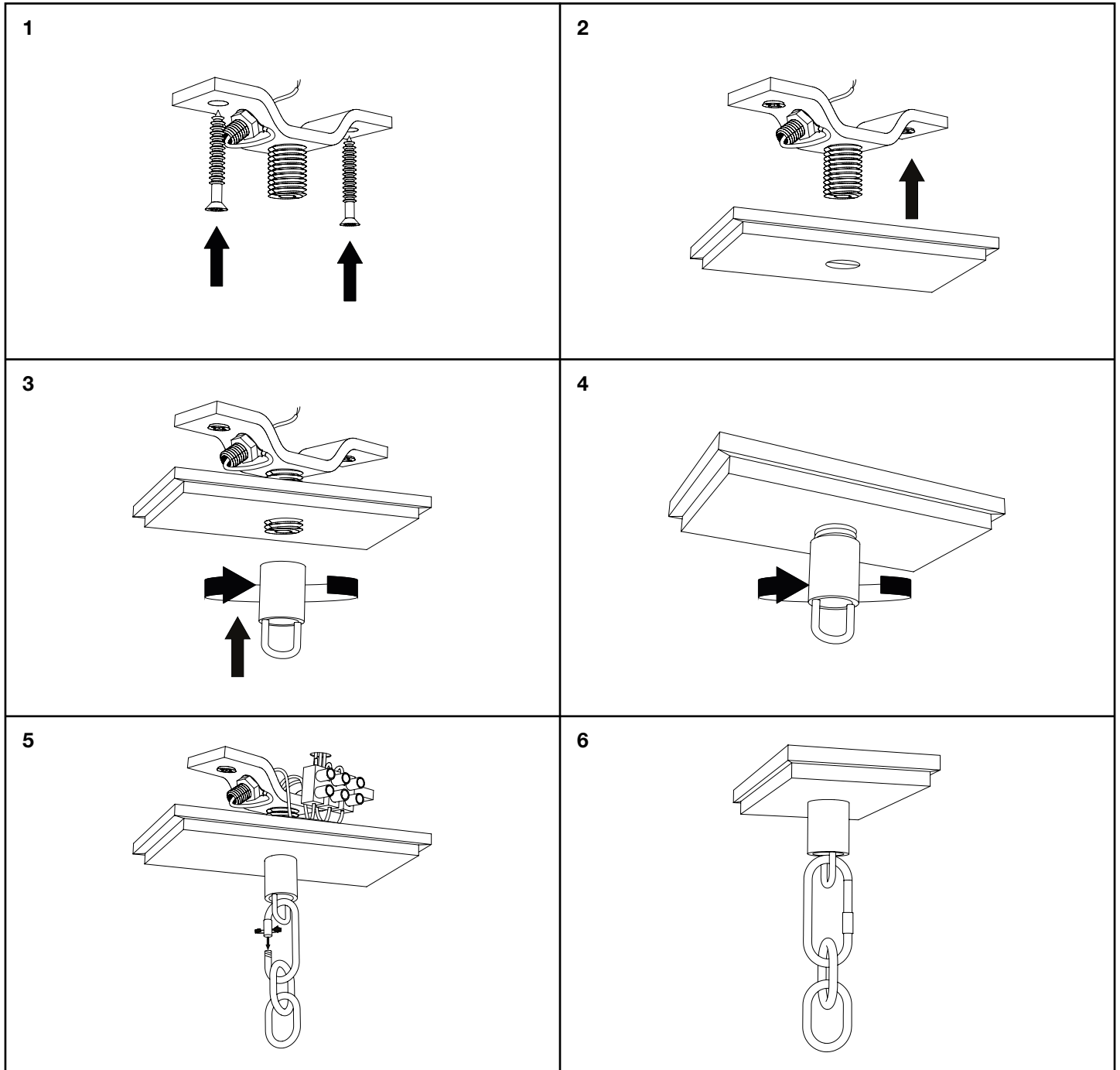

This product is for indoor use only. Outdoor use could result in shock, fire or serious bodily injury or death. All wiring must be done in accordance with national and local electric codes. It is strongly recommended that you use a qualified electrician.

Turn-off the electricity supply at the main circuit panel before installing. Do not connect the electricity supply until your lamp is fully assembled and installed.

Fix the ceiling bracket to the ceiling by using mounting plugs and screws suitable to your ceiling type and take into account the weight of your luminaire.

Connect the 3 power wires according to their colours. Brown is the live wire, blue is the neutral wire, the green yellow wire is the earthwire.