



E I C H H O L T Z

105937 LAMP LA MARINA

ASSEMBLY INSTRUCTION

- 1** Place the light on a flat surface, then loosen the two hand bolts on the handle. Bring the handle to a 90 degree position and tighten the bolts.

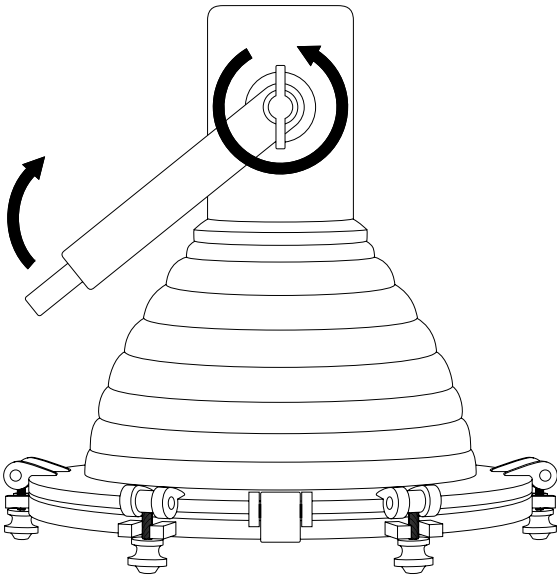

- 2** The handle should be positioned as shown in the image below.

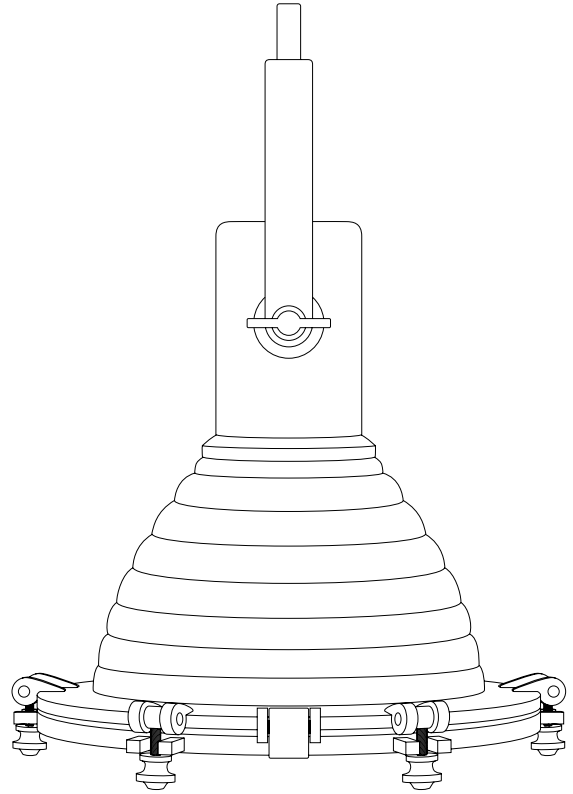

- 3** Place the light with the hinge side facing down towards the flat surface. As shown in the image below.

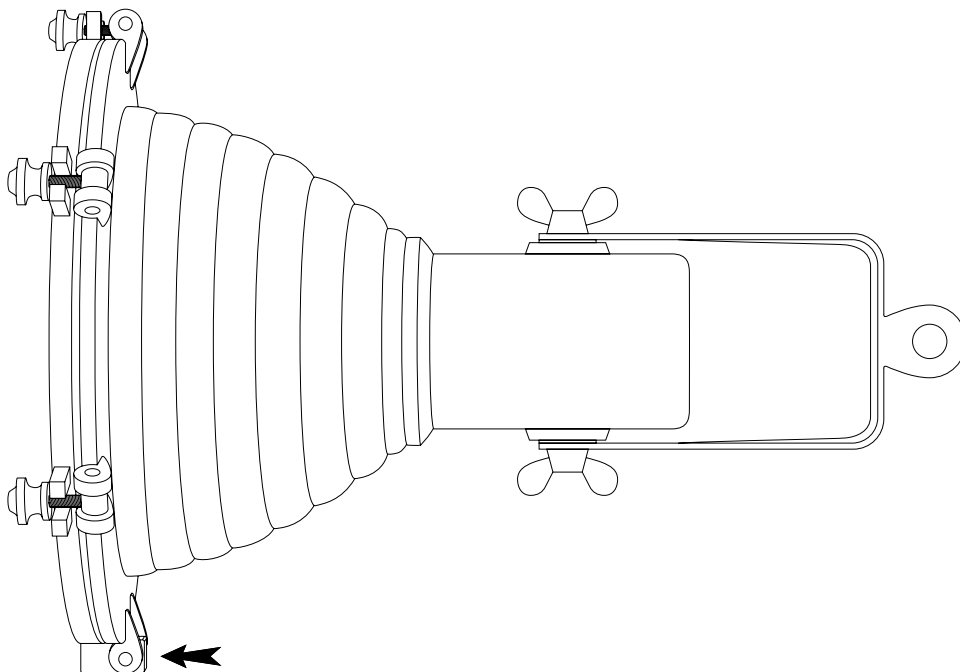



E I C H H O L T Z

105937 LAMP LA MARINA

ASSEMBLY INSTRUCTION

- 4 Loosen all the nuts and pull them sideways to unlock the front cover.

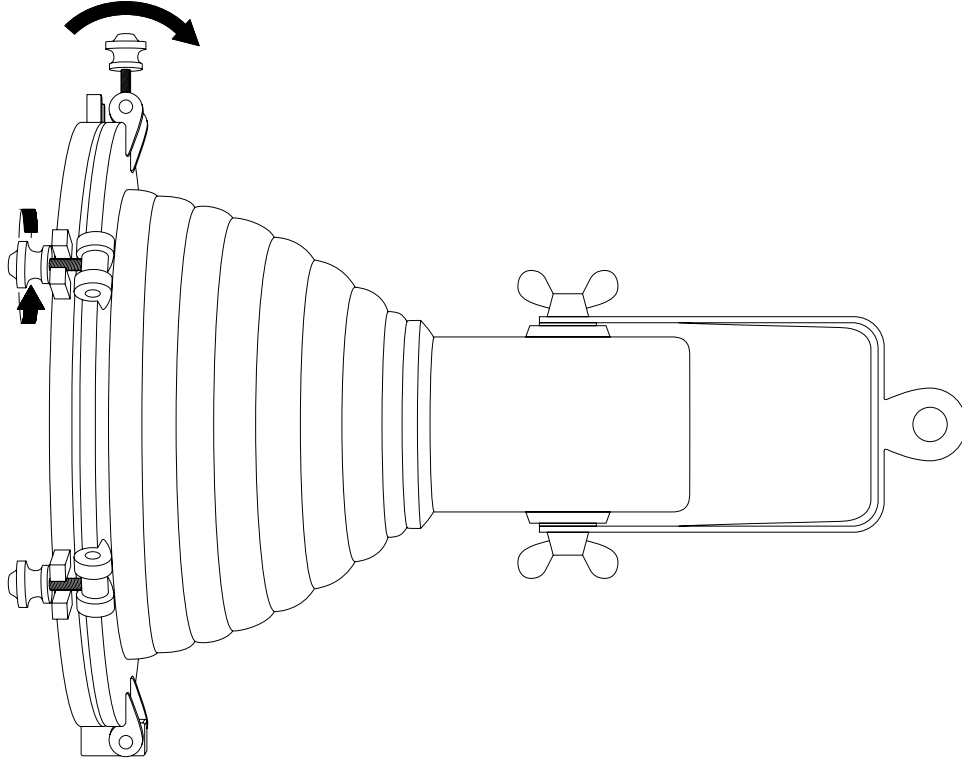

- 5 Carefully open the front cover. Place the bulb in the lamp holder. Carefully close the front cover, move the screws back to their original position and tighten the screws.

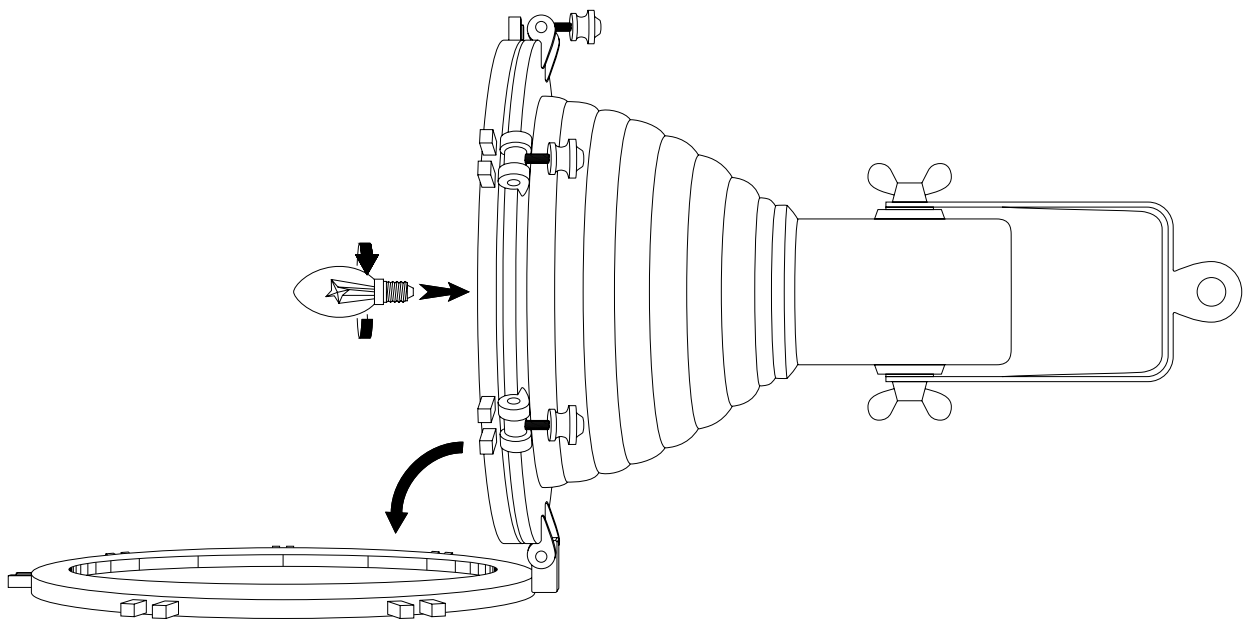



E I C H H O L T Z

105937 LAMP LA MARINA

ASSEMBLY INSTRUCTION

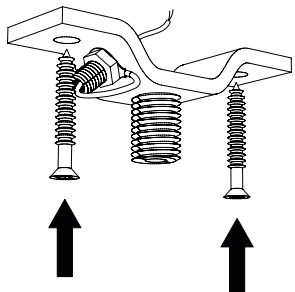
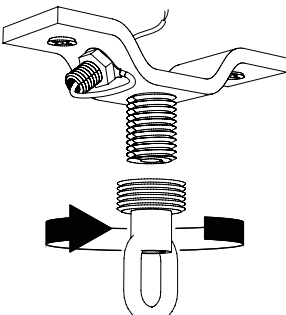
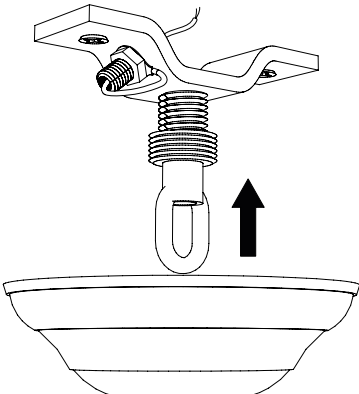
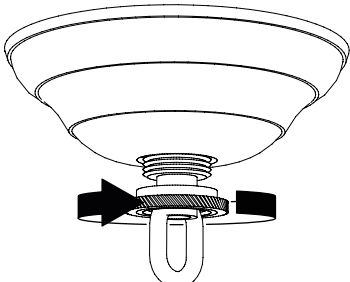
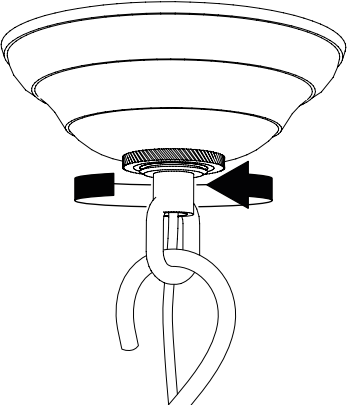
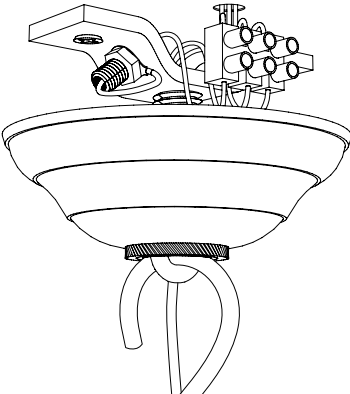
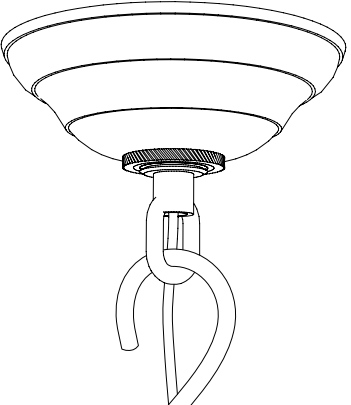
<p>1</p> 	<p>2</p> 
<p>3</p> 	<p>4</p> 
<p>5</p> 	<p>6</p> 
<p>7</p> 	<p>This product is for indoor use only. Outdoor use could result in shock, fire or serious bodily injury or death. All wiring must be done in accordance with national and local electric codes. It is strongly recommended that you use a qualified electrician.</p> <p>Turn-off the electricity supply at the main circuit panel before installing. Do not connect the electricity supply until your lamp is fully assembled and installed.</p> <p>Fix the ceiling bracket to the ceiling by using mounting plugs and screws suitable to your ceiling type and take into account the weight of your luminaire.</p> <p>Connect the 3 power wires according to their colours. Brown is the live wire, blue is the neutral wire, the green yellow wire is the earthwire.</p>