

Item type

Pendant

Item name

Etruscan

Item no

114858

Attention! Do not connect your luminaire to electricity until it is fully assembled.

Care instructions:

Wipe with a soft dry cloth, do not use chemicals or abrasive cleaning materials.

Eichholtz B.V.

Delfweg 52
2211 VN Noordwijkerhout
The Netherlands

🏠 www.eichholtz.com
✉ service@eichholtz.com
☎ +31 (0)252 515 850

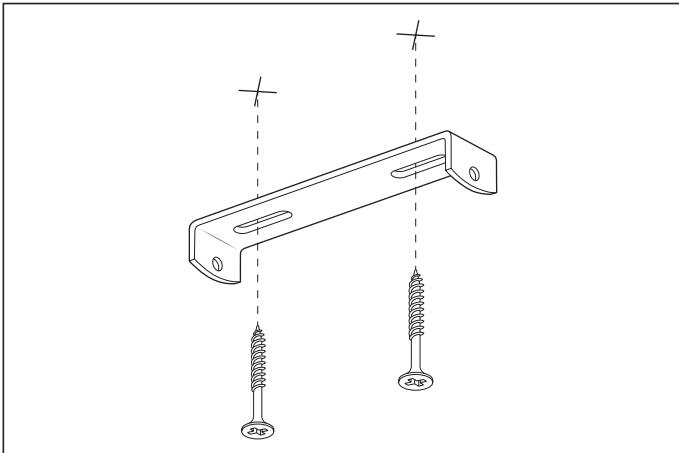

1. Fix the crossbar to the ceiling by using mounting plugs and screws suitable to your ceiling type.

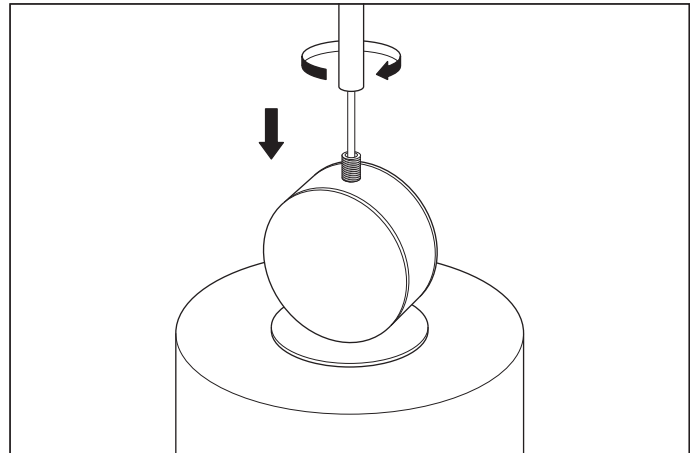

2. Determine the desired height of the lamp and connect either one, two or three of the pipes supplied. Thread the wire through the pipes.

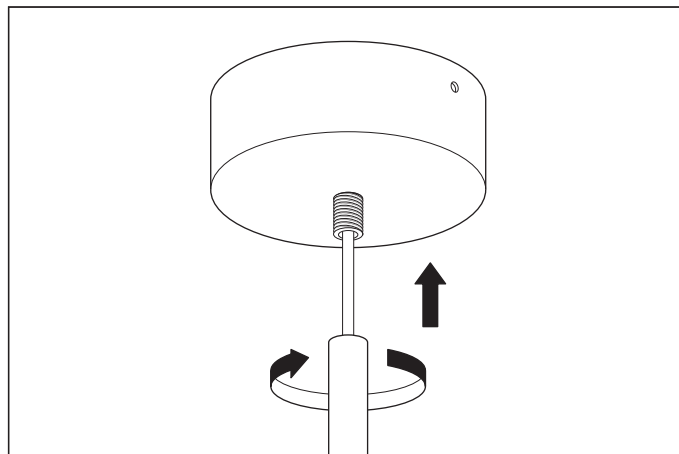

3. Place or hold the lamp in an elevated position in such a way that the wires can freely reach the ceiling junction box.

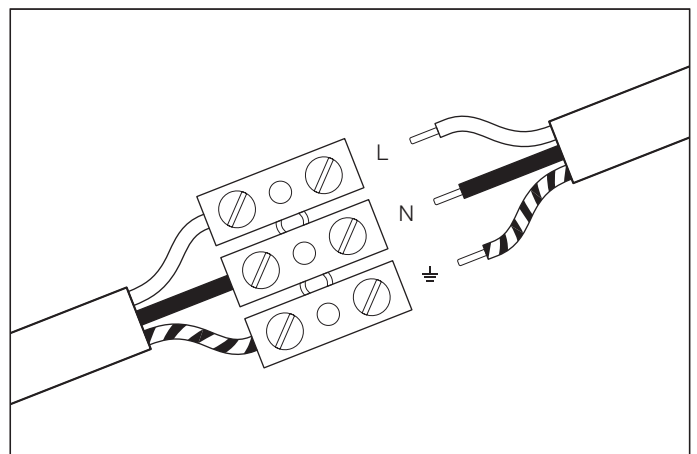

4. Connect the 3 wires according to their colours. Brown is the live wire, blue is the neutral wire, green/yellow is the earth wire.

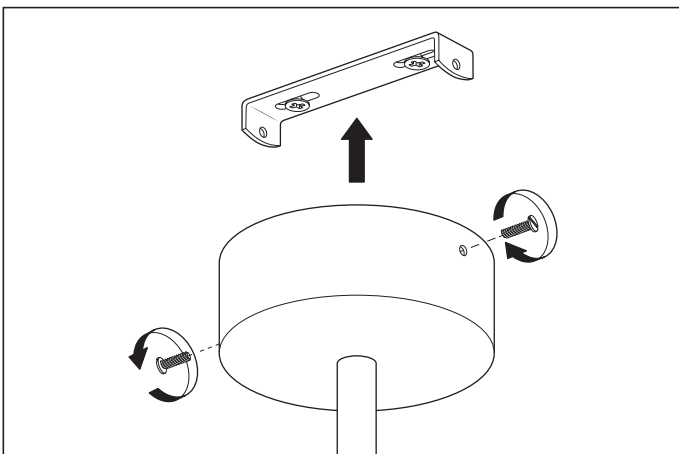

5. Place the ceiling canopy over the crossbar and fix it securely with the screws on the sides.

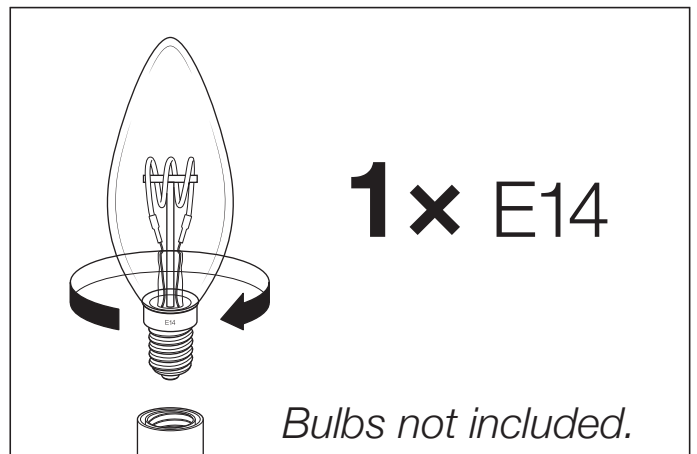

6. Carefully place the bulb in the fittings. Do NOT turn the bulb further than necessary, to prevent damage to the fitting.