

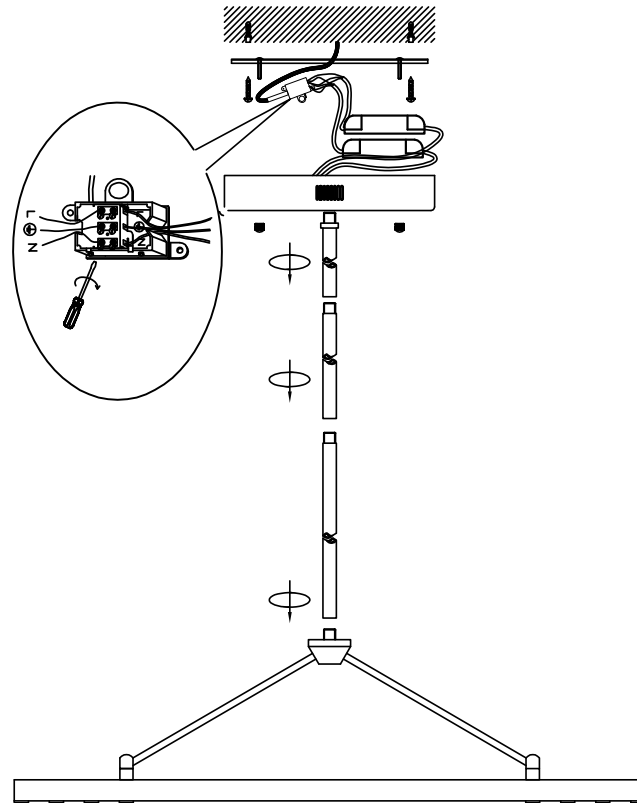

E I C H H O L T Z

113445 CHANDELIER CASSINI

ASSEMBLY INSTRUCTION



This product is for indoor use only. Outdoor use could result in shock, fire or serious bodily injury or death.

All wiring must be done in accordance with national and local electric codes. It is strongly recommended that you use a qualified electrician.

Turn-off the electricity supply at the main circuit panel before installing. Do not connect the electricity supply until your lamp is fully assembled and installed.

Fix the ceiling bracket to the ceiling by using mounting plugs and screws suitable to your ceiling type and take into account the weight of your luminaire.

Connect the canopy and lamp with rods.

Connect the 3 power wires according to their colours. Brown is the live wire, blue is the neutral wire, the green yellow wire is the earthwire.