

LAY OUT 124 ANO
LAY OUT 154 ANO
LAY OUT 254 ANO

DEEL
PARTIE
TEIL
PART
PARTE
PARTE

A CE

DELTA LIGHT

Delta Light® nv.
Muizelstraat 2
B- 8560 Wevelgem (Moorsele)
Belgium
Phone: +32(0)56 435 735
Fax: +32(0)56 435 736
E-mail: enter@deltalight.com
www.deltalight.com

L.E.B. A4

ACCESSORIES / OPTIONS:

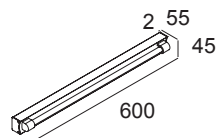

LAY OUT 124 ANO
338 01 124 ANO

G5 / 220-240V / 50-60Hz / 1 x 1~EVG
1 x T16 24W

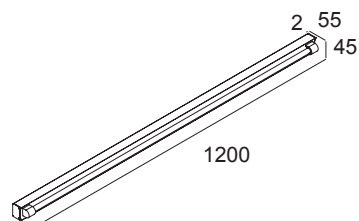

LAY OUT 154 ANO
338 01 154 ANO

G5 / 220-240V / 50-60Hz / 1 x 1~EVG
1 x T16 54W

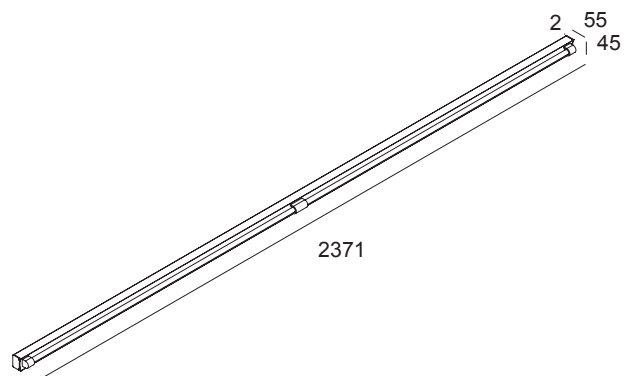

LAY OUT 254 ANO
338 01 254 ANO

G5 / 220-240V / 50-60Hz / 1 x 2~EVG
2 x T16 54W



WAARSCHUWING Lees de algemene gebruiksvoorwaarden : **DEEL B**
AVERTISSEMENT Lire attentivement les conditions générales d'utilisation : **PARTIE B**
WARNUNG Lesen Sie die allgemeinen Gebrauchsanweisungen : **TEIL B**
WARNING Read the general directions : **PART B**
AMMONIZIONE Leggere attentamente le condizioni generali di utilizzazione : **PARTE B**
EDVERTENCIA Leer atentamente las condiciones generales de uso : **PARTE B**



 Minimum afstand van de verlichte voorwerpen (meter)
Distance minimale par rapport aux objets éclairés (mètres)
Mindestabstand von beleuchteten Gegenständen (Meter)
Minimum distance from lighted objects (metres)
Distancia mínima de los objetos iluminados (metros)
Distanza min. dagli oggetti illuminati (metri)

 Bevestiging wand - plafond opbouw
Montage mur - plafond appliqué
Montage wand - decke aufgebaut
Fixation wall - ceiling surface mounted
Montaje pared - techo montado al superficie
Montaggio parete - soffitto montato a superficie

 Installeer het armatuur enkel in ruimten waar direct contact met water onmogelijk is.
Cet équipement doit être installé dans des pièces hors de toute projection d'eau.
Diese Leuchte darf nur in Räumen verwendet werden, in denen ein direkter Kontakt mit Wasser nicht möglich ist.
This fitting should only be installed in rooms where direct contact with water is impossible.
Este aparato solamente puede ser instalado en habitaciones donde el contacto directo con el agua sea imposible.
Questo apparecchio di illuminazione deve essere installato solamente in locali in cui il contatto con l'acqua è impossibile.

LAY OUT 124 ANO
 LAY OUT 154 ANO
 LAY OUT 254 ANO

INSTALLATION INSTRUCTIONS - PART A

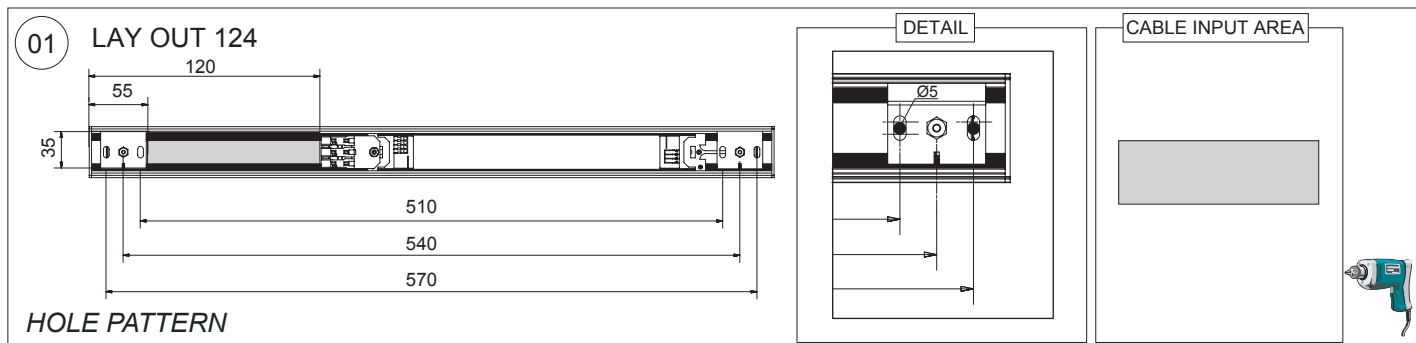

01. MAKE HOLE PATTERN
02. REMOVE THE FITTING COVER
03. FIT THE WALL / CEILING FIXATION
04. ON THE WALL / CEILING MAKE THE ELECTRICAL CONNECTION
05. PLACE THE DEVICE
06. INSERT/REPLACE LAMP
07. PLACE THE FITTING COVER
08. SWITCH ON

