

**BUTLER P 304**  
**BUTLER P 304 DOWN UP**

DEEL  
PARTIE  
TEIL  
PART  
PARTE  
PARTE

# A

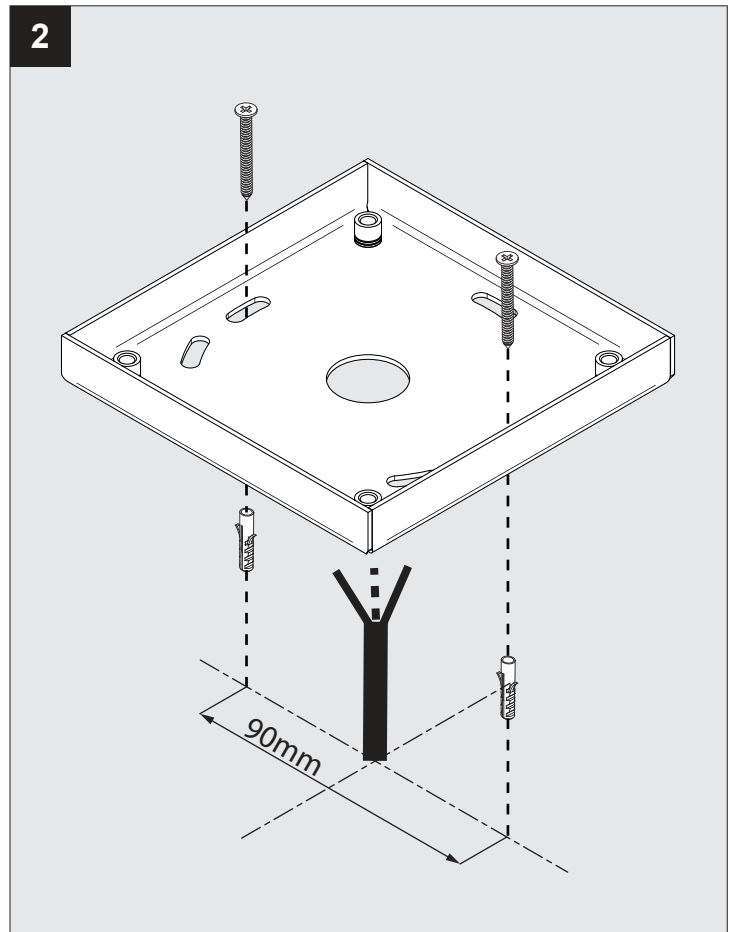
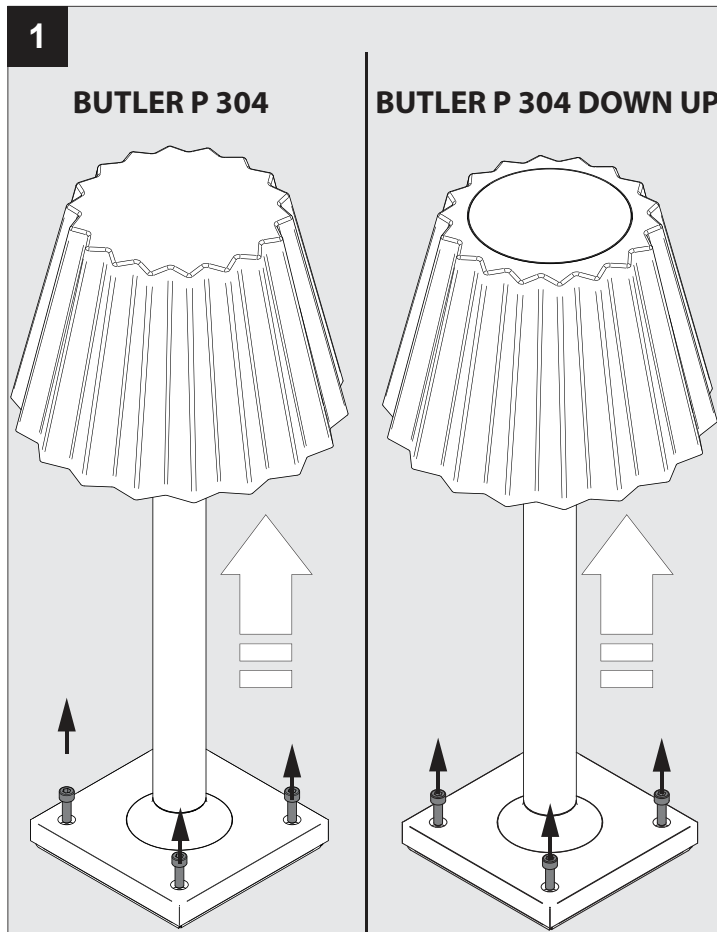
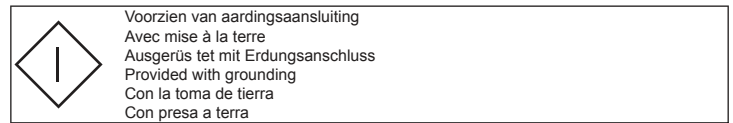
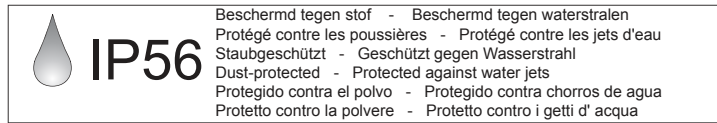
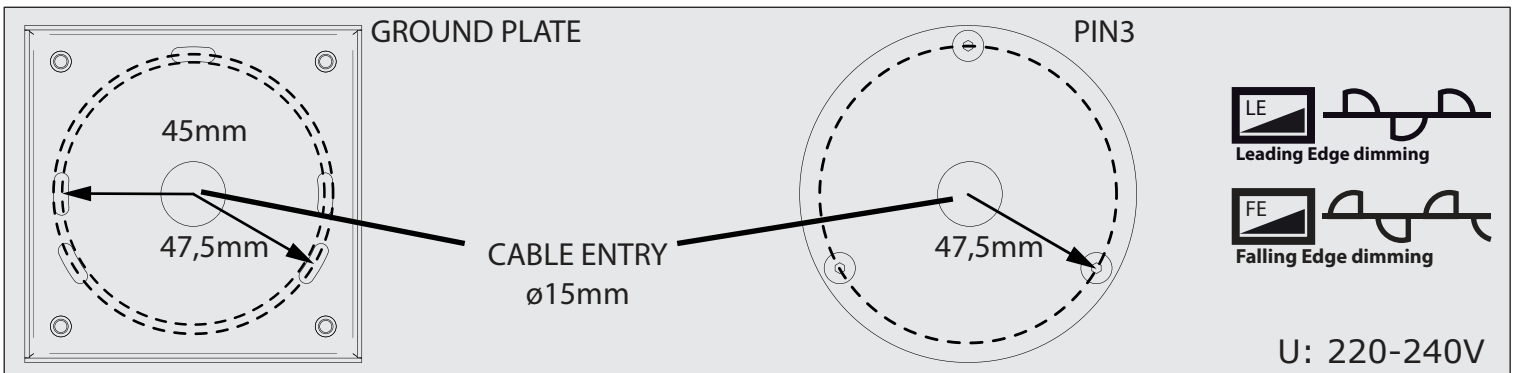
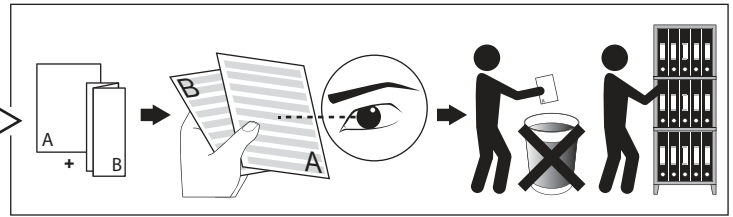
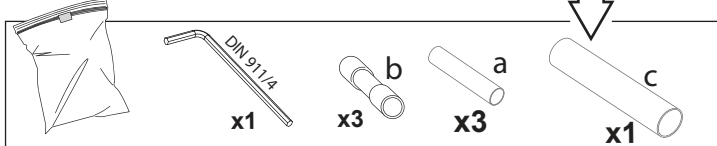

**3a OPTIONAL  
PIN 3**

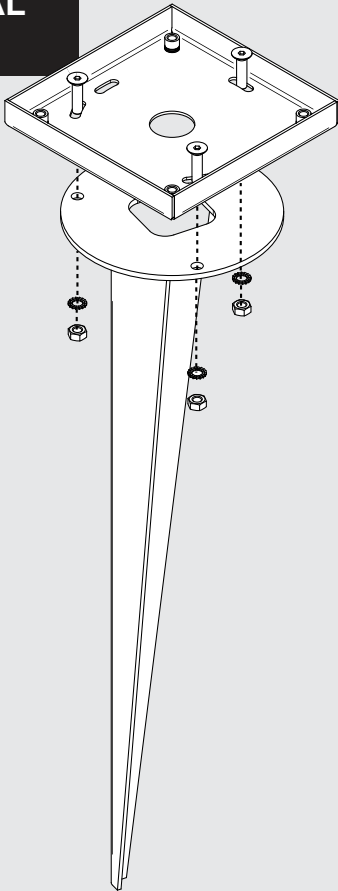

**3b OPTIONAL  
PIN 3**

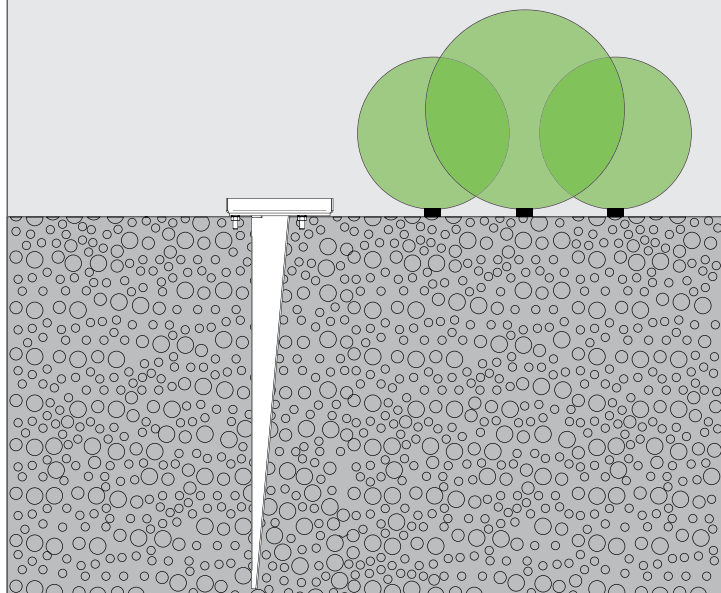

**4**

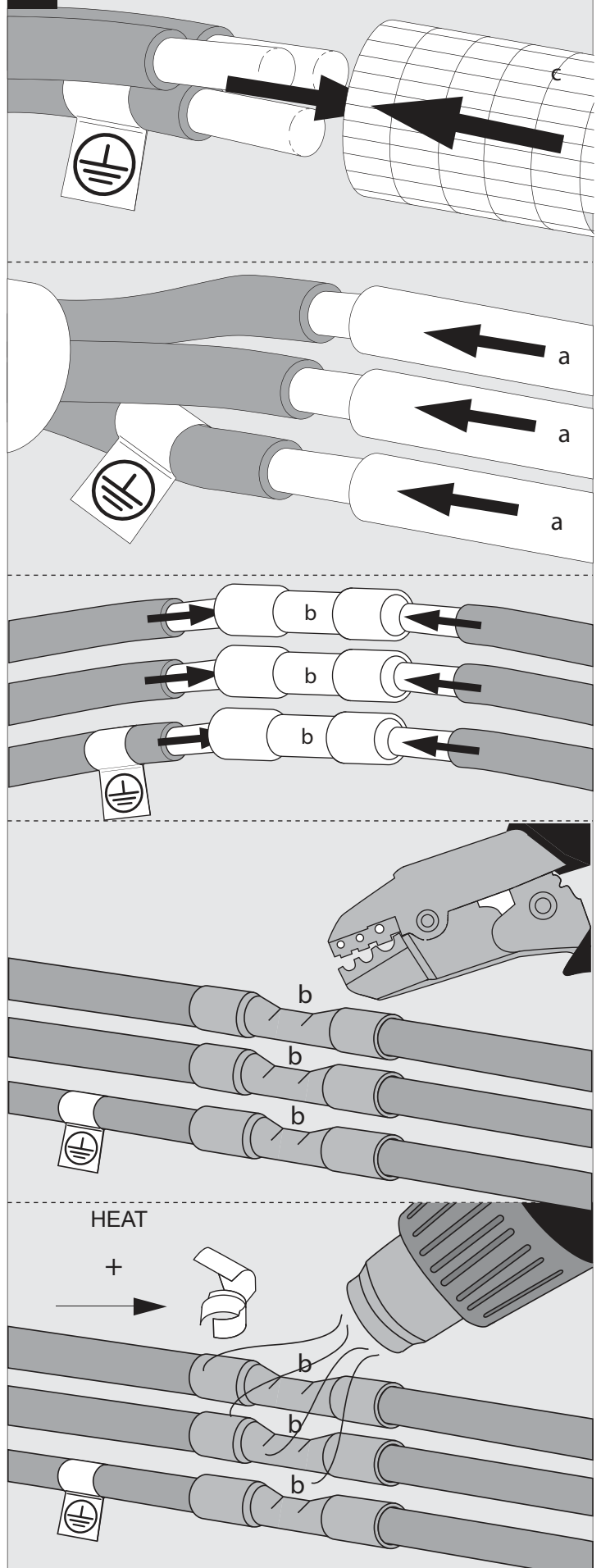

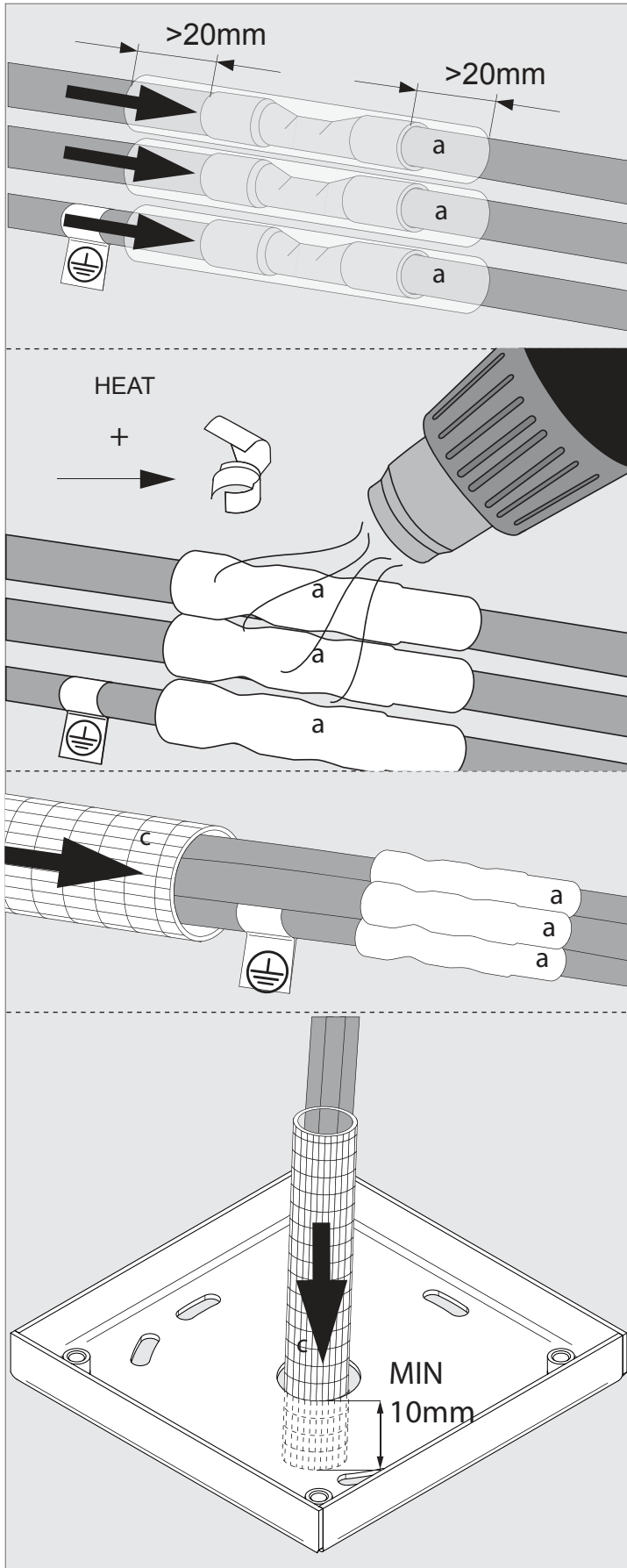

**5 BUTLER P 304**

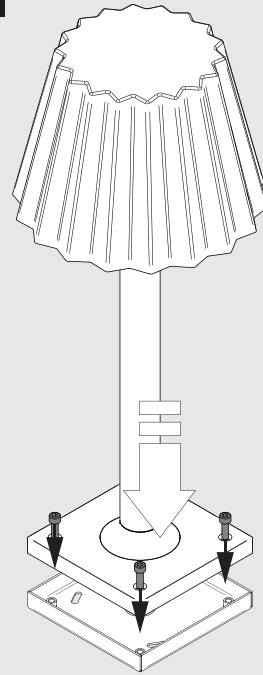

**BUTLER P 304 DOWN UP**

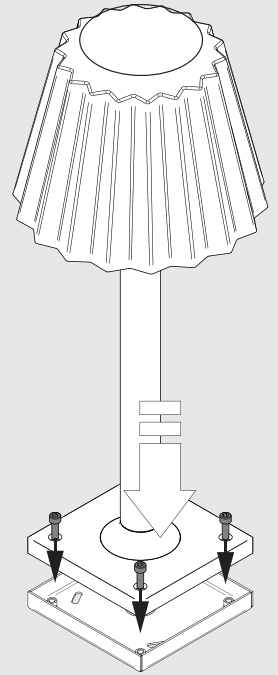

**6 BUTLER P 304**

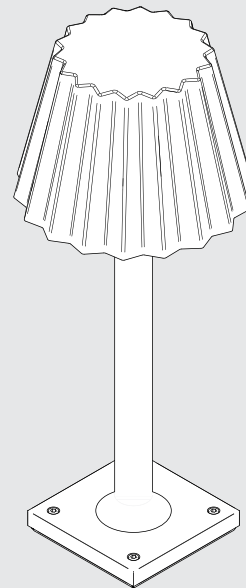

**BUTLER P 304 DOWN UP**

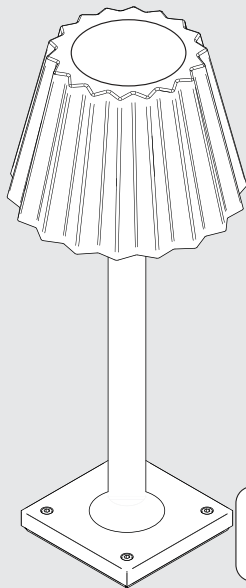

De verlichtingsbron van dit verlichtingstoestel zal enkel door de fabrikant of door de fabrikant aangestelde installateur worden vervangen worden.

La source lumière de cet appareil ne sera remplacée que par l'entreprise ou par un agent reconnu.

Das enthaltene Leuchtmittel sollte nur durch entsprechendes Fachpersonal ersetzt werden.

The light source contained in this luminaire shall only be replaced by the manufacturer or his service agent.

La fuente de iluminación que tiene esta luminaria sólo puede remplazarse por el fabricante o por un instalador autorizado.

La sorgente luminosa incorporata in questo apparecchio può essere sostituita solo dal produttore, da un suo centro assistenza oppure da una persona in possesso della necessaria abilitazione.