

BEGA**50 704.2**

Pendant luminaire for indoor use

Project · Reference number

Date

Product data sheet

Application

Pendant luminaire · indoor luminaire with annular metal shield and hand-blown opal glass for reduced lateral glare and high-contrast lighting by deflected light predominantly downwards.

Product description

Metal luminaire housing and annular shield, finish stainless steel
 Hand-blown opal glass
 Black flex suspension $2 \times 0,75 \square$
 Overall length of luminaire approx. 2000 mm
 Connecting terminal DA DA for digital control
 LED power supply unit inside canopy
 220-240 V \sphericalangle 0/50-60 Hz
 DC 170-280 V
 DALI controllable
 A basic isolation exists between power cable and control line
 Safety class I
CE – Conformity mark

Light technique

Luminaire data for the light planning program DIALux for outdoor lighting, street lighting and indoor lighting as well as luminaire data in EULUMDAT- and IES-format you will find on the BEGA web page www.bega.com.

Lamp

Module connected wattage	17.7 W
Luminaire connected wattage	20.4 W
Rated temperature	$t_a = 25 \text{ }^\circ\text{C}$
Ambient temperature	$t_{a \text{ max}} = 50 \text{ }^\circ\text{C}$

50 704.2 K3

Module designation	LED-0406/930
Colour temperature	3000 K
Colour rendering index	CRI > 90
Module luminous flux	2745 lm
Luminaire luminous flux*	1640 lm
Luminaire luminous efficiency*	80,4 lm/W

50 704.2 K4

Module designation	LED-0406/940
Colour temperature	4000 K
Colour rendering index	CRI > 90
Module luminous flux	2830 lm
Luminaire luminous flux*	1690 lm
Luminaire luminous efficiency*	82,8 lm/W

* preliminary data

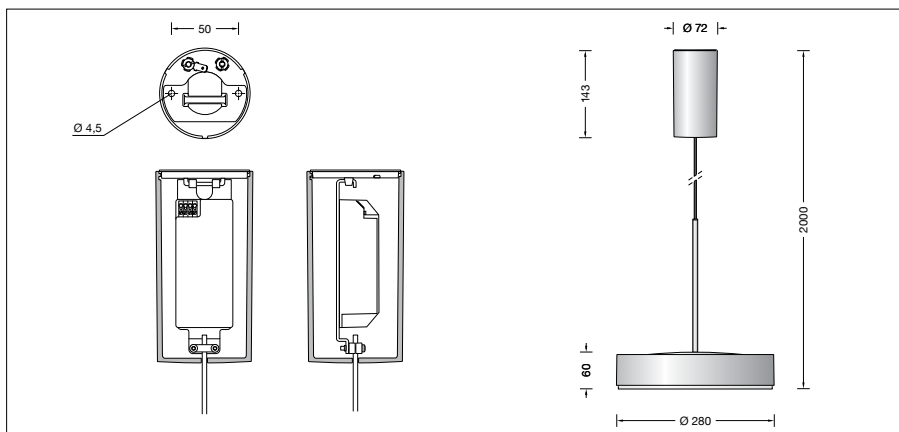
**Lifetime of the LED**

Ambient temperature $t_a = 15 \text{ }^\circ\text{C}$
 – at 50,000h: L90B10
 – at > 500,000h: L70B50

Ambient temperature $t_a = 25 \text{ }^\circ\text{C}$
 – at 50,000h: L90B10
 – at 412,000h: L70B50

max. ambient temperature $t_a = 50 \text{ }^\circ\text{C}$
 – at 50,000h: L80B50
 – at 92,000h: L70B50

Article No. 50 704.2

LED colour temperature optionally 3000 K or 4000 K
 3000 K – Article number + **K3**
 4000 K – Article number + **K4**

Finish options

- Enamel, white Code number **.1**
- Enamel, velvet black, matt Code number **.5**
- Stainless steel Code number **.2**
- Chrome Code number **.3**