

**BEGA****50 553.3**

Pendant luminaire for large rooms · Chandelier for indoor use

Project · Reference number

Date

**Product data sheet****Application**

LED chandelier · indoor luminaire for unshielded and uniform light with hand-blown opal glass, metal housing and rod suspension.  
The luminaire features high light output.  
Light emission on one side.

**Product description**

Polished aluminium chandelier, rod suspension and canopy  
Hand-blown opal glasses with screw neck  
Diameter of rod 16 mm  
Rod suspension in single units each 600 mm in length  
Overall length of luminaire approx. 1660 mm  
Connection terminal 2.5<sup>□</sup>  
Earth conductor connection  
LED power supply unit inside canopy  
100-277 V ~ 50/60 Hz  
DALI controllable  
A basic isolation exists between power cable and control line  
Safety class I  
CE – Conformity mark  
Weight: 11.9 kg

**Light technique**

Luminaire data for the light planning program DIALux for outdoor lighting, street lighting and indoor lighting as well as luminaire data in EULUMDAT- and IES-format you will find on the BEGA web page [www.bega.com](http://www.bega.com).

**Lamp**

Module connected wattage	57.6 W
Luminaire connected wattage	65 W
Rated temperature	$t_a = 25\text{ °C}$
Ambient temperature	$t_{a\text{ max}} = 55\text{ °C}$

**50 553.3 K3**

Module designation	6x LED-0878/930
Colour temperature	3000 K
Colour rendering index	CRI > 90
Module luminous flux	9420 lm
Luminaire luminous flux	7404 lm
Luminaire luminous efficiency	113,9 lm/W

**50 553.3 K4**

Module designation	6x LED-0878/940
Colour temperature	4000 K
Colour rendering index	CRI > 90
Module luminous flux	9720 lm
Luminaire luminous flux	7639 lm
Luminaire luminous efficiency	117,5 lm/W

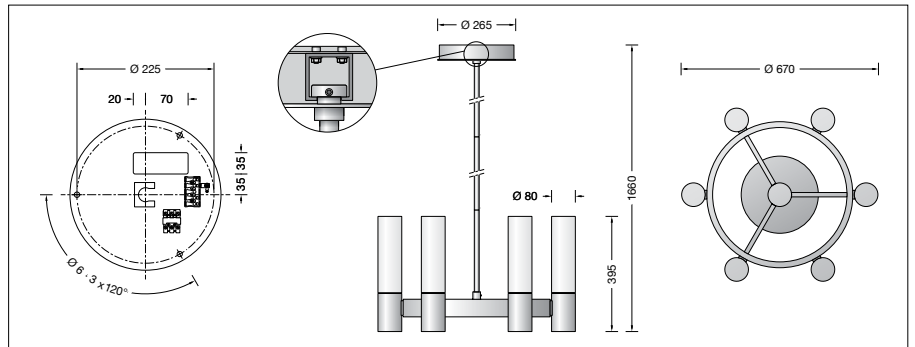
**Service life of the LED**

Ambient temperature  $t_a = 25\text{ °C}$   
– at 423,000h: L70B50

max. ambient temperature  $t_a = 55\text{ °C}$   
– at 72,000h: L70B50

**Article No. 50 553.3**

LED colour temperature optionally 3000K or 4000K

3000 K – Article number + **K3**  
4000 K – Article number + **K4**