

**BEGA****45 729.2 P**

Pendant luminaire for indoor use

Project · Reference number

Date

**Product data sheet****Application**

Pendant luminaire · indoor luminaire for free-radiating and uniform light with white synthetic globe.

With metal housing and rod.

**Product description**

Fitter, rod suspension and canopy

made of stainless steel

White synthetic globe

Diameter of rod 13 mm

Overall length of luminaire approx. 2000 mm

Lampholder E 27

Safety class I

CE – Conformity mark

Weight: 5.1 kg

**Light technique**

Luminaire data for the light planning program DIALux for outdoor lighting, street lighting and indoor lighting as well as luminaire data in EULUMDAT- and IES-format you will find on the BEGA web page [www.bega.com](http://www.bega.com).

**Lamps**

Luminaire with lampholder E 27

Lamp output max. 150 W

For this luminaire we recommend the following BEGA LED lamps:

**13 510** LED 7 W · 805 lm · 2700 K

**13 548** LED 7 W · 805 lm · 2700 K  
dimnable

**13 512** LED 8 W · 1055 lm · 2700 K

**13 564** LED 12 W · 1400 lm · 2700 K

**13 565** LED 12 W · 1400 lm · 2700 K  
dimnable

Detailed technical and lighting data for the lamps can be found in the data sheets on our website.

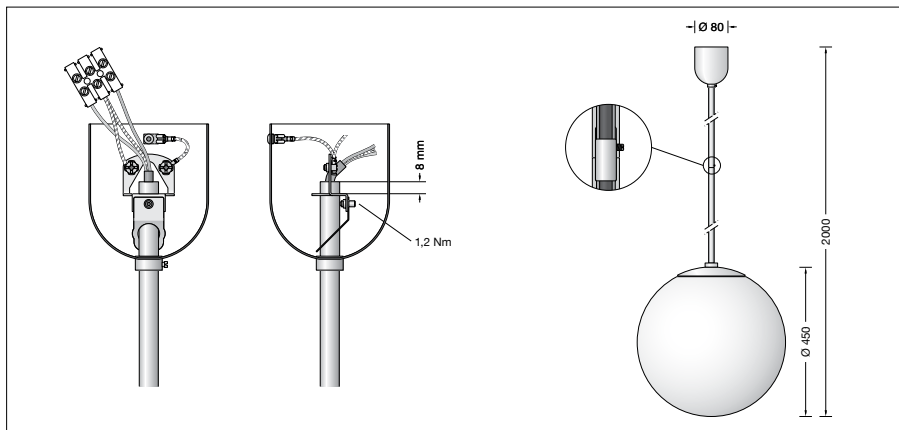
**Article No. 45 729.2 P**

Optional finishes

- White enamel
- Stainless steel
- Chrome
- Brass

code number **.1**

code number **.2**

code number **.3**

code number **.4**