

BEGA**45 729.1**

Pendant luminaire for indoor use

Project · Reference number

Date

Product data sheet

Application

Pendant luminaire · indoor luminaire for free-radiating and uniform light with hand-blown opal glass, satin matt.
With metal fitting and rod.

Product description

Metal housing, rod suspension and canopy, finish white enamel
Hand-blown opal glass, satin matt
Diameter of rod 13 mm
Overall length of luminaire approx. 2000 mm
Connection terminal 2.5²
Earth conductor connection
Lampholder E 27
Safety class I
CE – Conformity mark
Weight: 5.1 kg

Light technique

Luminaire data for the light planning program DIALux for outdoor lighting, street lighting and indoor lighting as well as luminaire data in EULUMDAT- and IES-format you will find on the BEGA web page www.bega.com.

Lamps

Luminaire with lampholder E 27
Lamp output max. 200 W

For this luminaire we recommend the following BEGA LED lamps:

13510 LED 7 W · 805 lm · 2700 K

13548 LED 7 W · 805 lm · 2700 K
dimnable

13512 LED 8 W · 1055 lm · 2700 K

13564 LED 12 W · 1400 lm · 2700 K

13565 LED 12 W · 1400 lm · 2700 K
dimnable

Detailed technical and lighting data for the lamps can be found in the data sheets on our website.

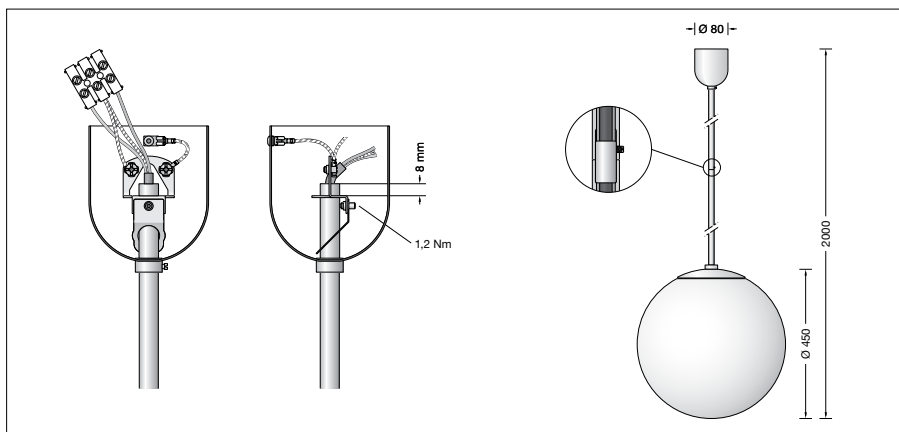
**Article No. 45 729.1**

Optional finishes

- White enamel code number **.1**
- Stainless steel code number **.2**
- Chrome code number **.3**
- Brass code number **.4**

If the article number is followed by a **P**, we can also supply these luminaires in impact-resistant synthetic material.