

Artemide®

TOLOMEO SOSPENSIONE OUTDOOR LAMPIONE

design
M. De Lucchi
G. Fassina

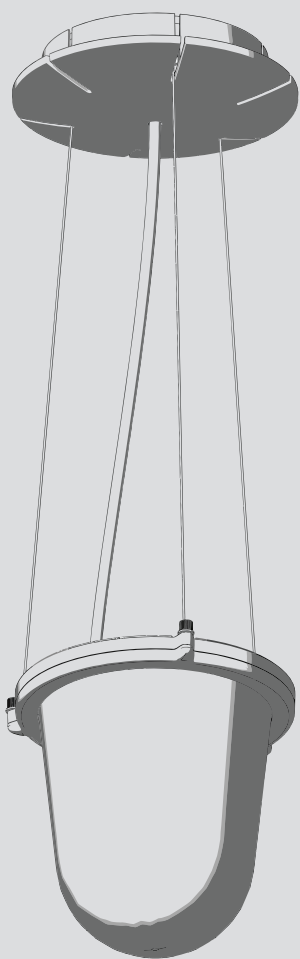



i

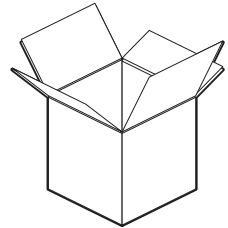
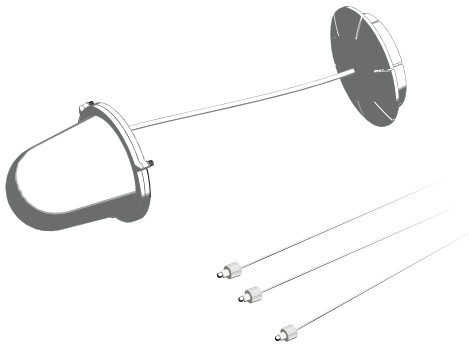
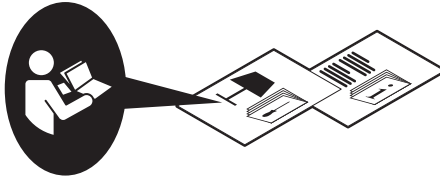
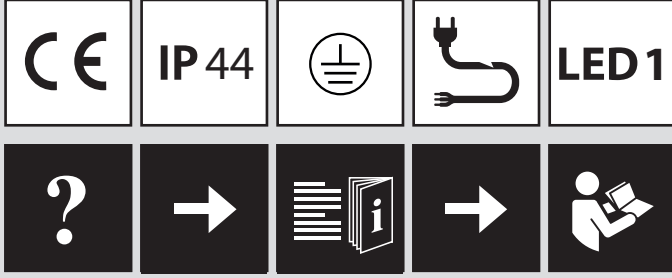

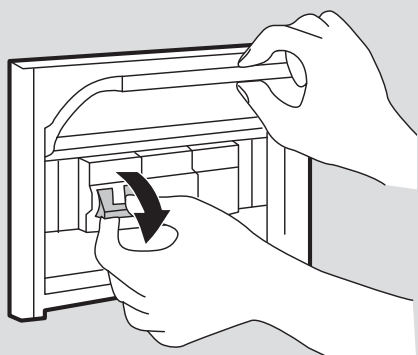

1

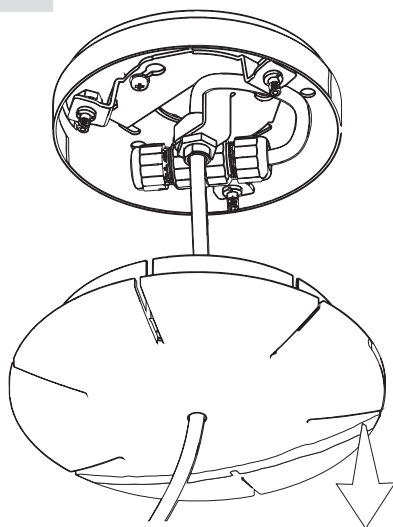

2

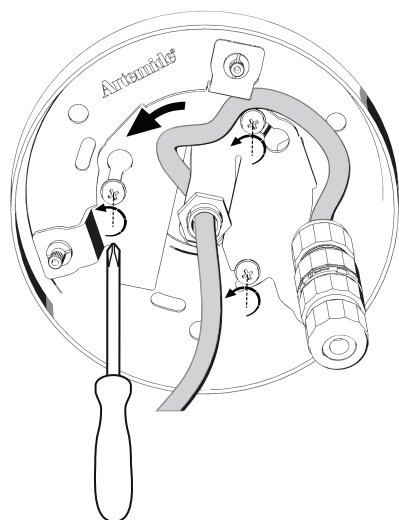

3

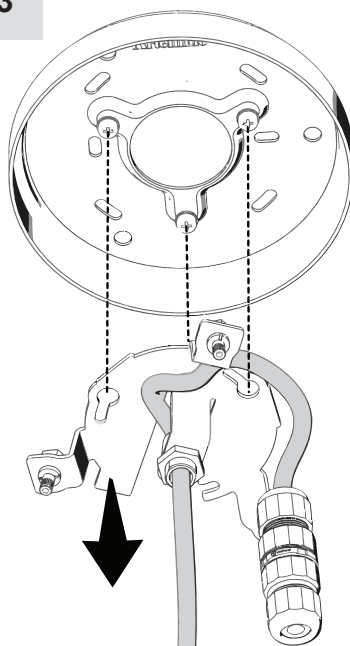

4

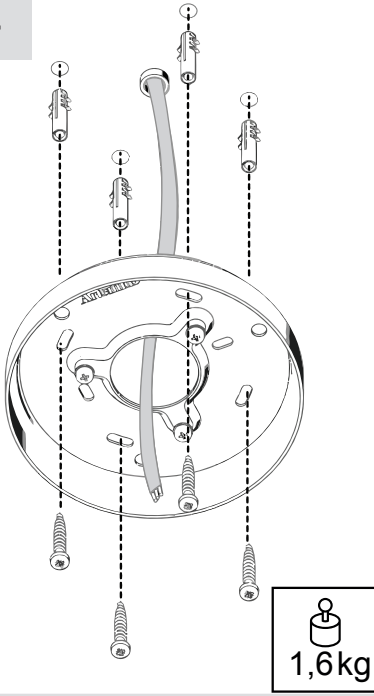

5

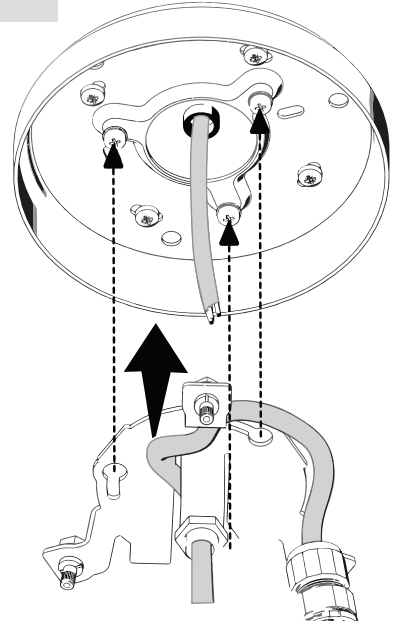

6

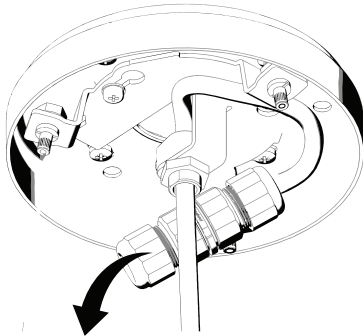

7

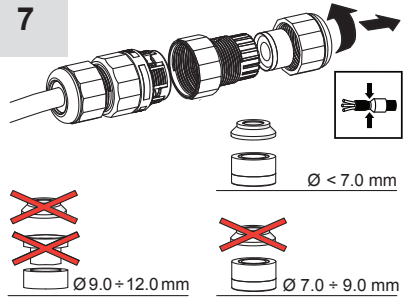

8

Input 220 - 240 Vac

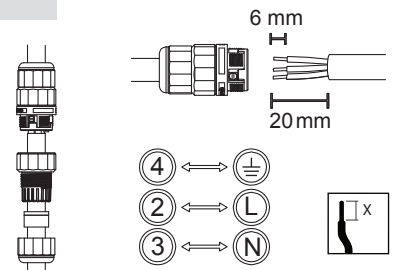

9

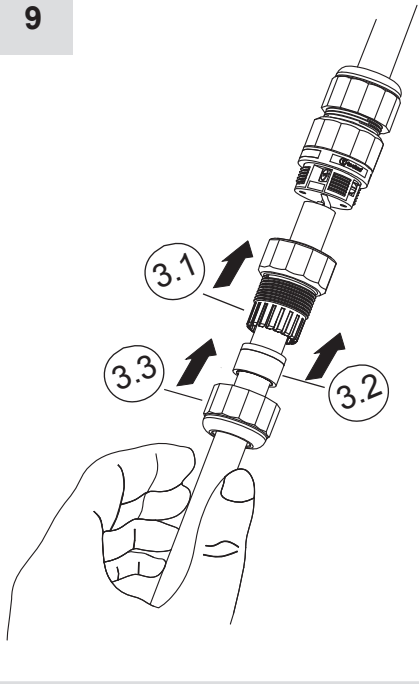

10a

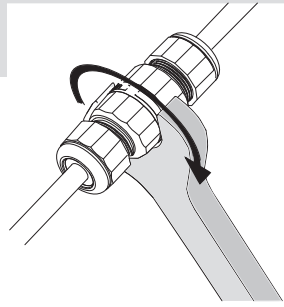

10b

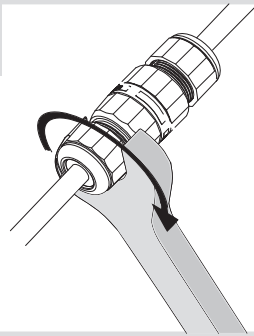

11

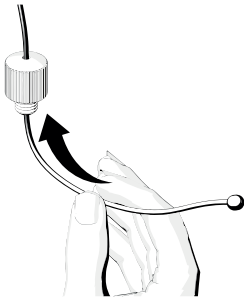

12

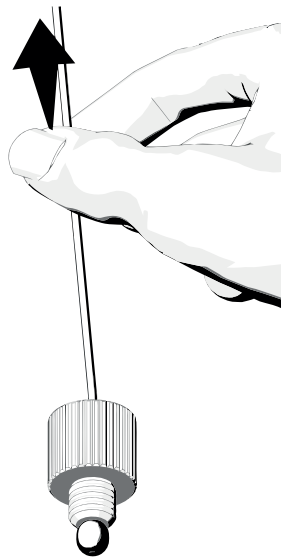

13

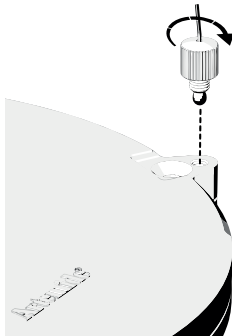

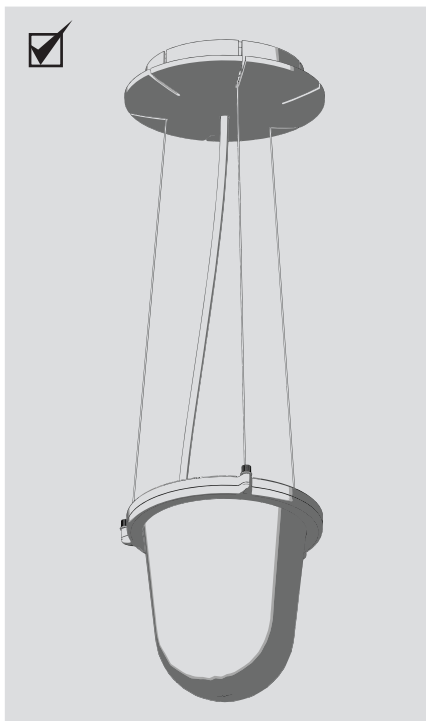
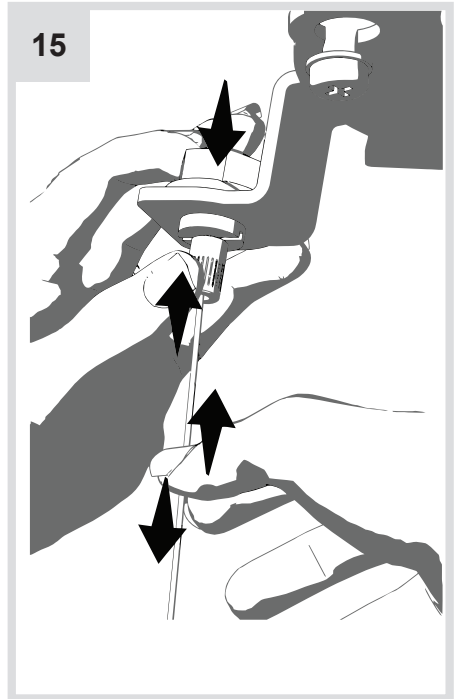
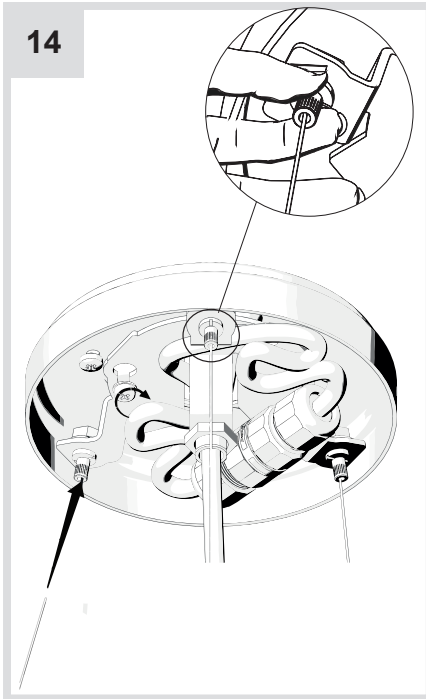

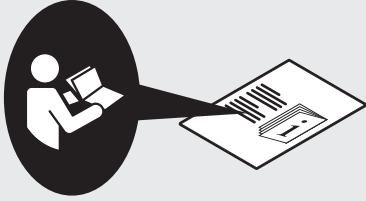

Artemide[®]
ARCHITECTURAL

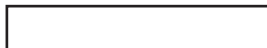

Artemide Spa

via Bergamo, 18
20010 Pregnana M.se (MI)
ITALIA

Tel. +39 02 935 181
Fax +39 02 935 90 254
Fax +39 02 935 90 496

www.artemide.com

VAT IT00846890150

cod. Y513000537