

Artemide®

Meteorite 15

design
Pio & Tito Toso

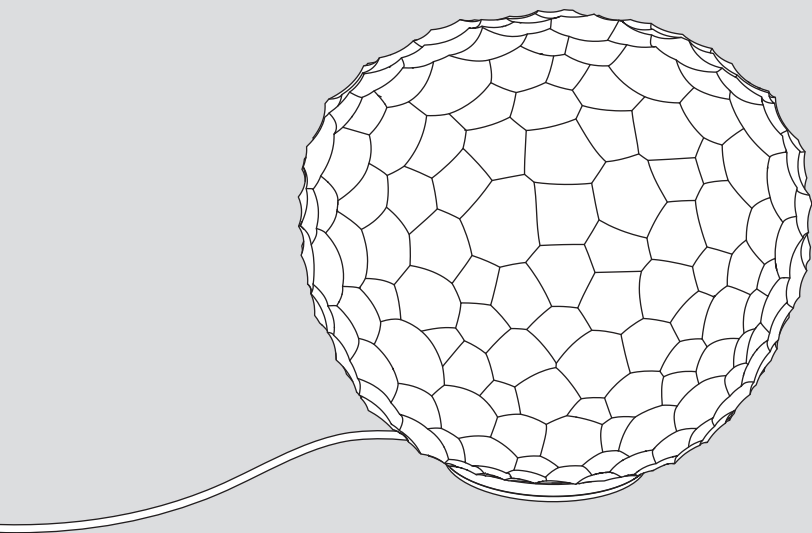



i

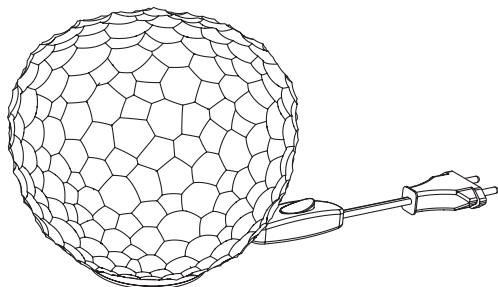
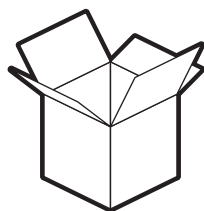
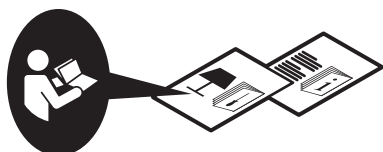
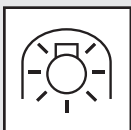
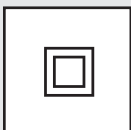

1

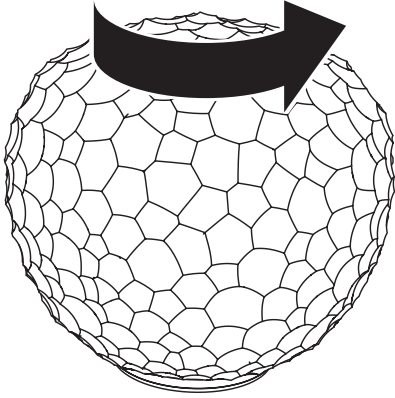

2

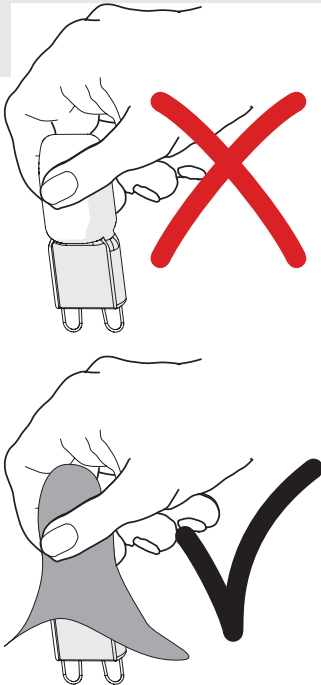
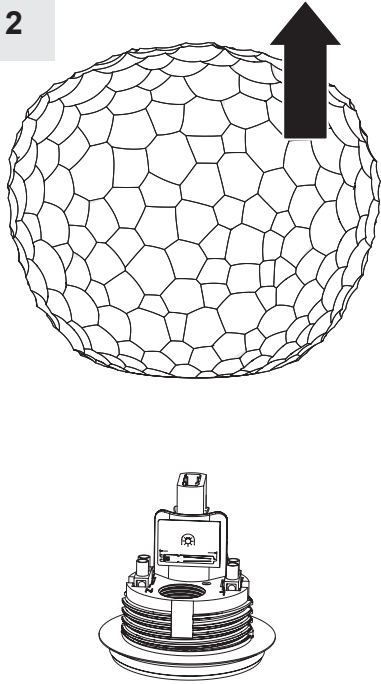

3

G9 - MAX 33W

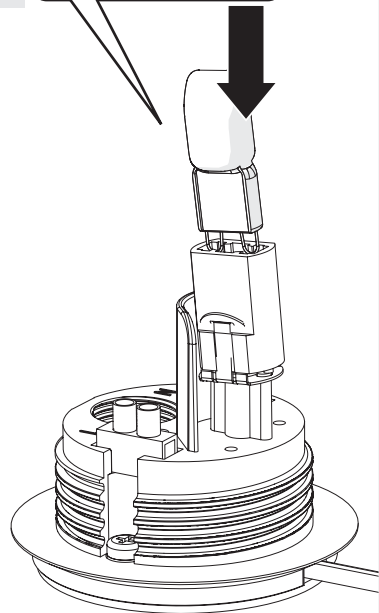

4

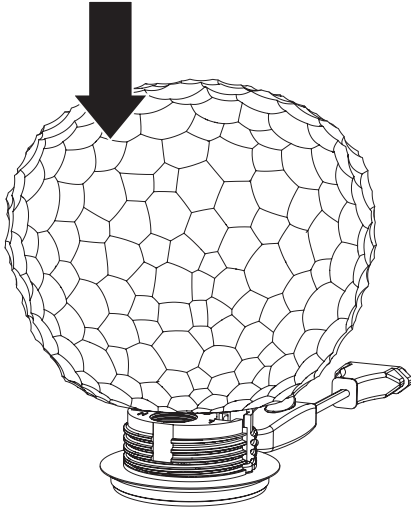

5

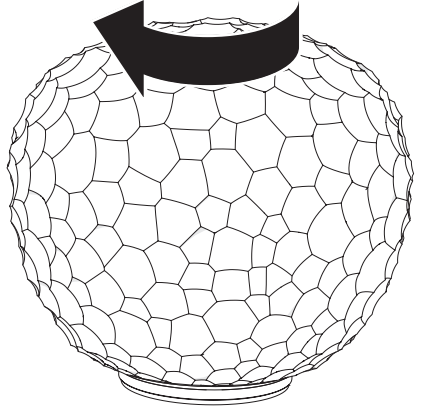

6

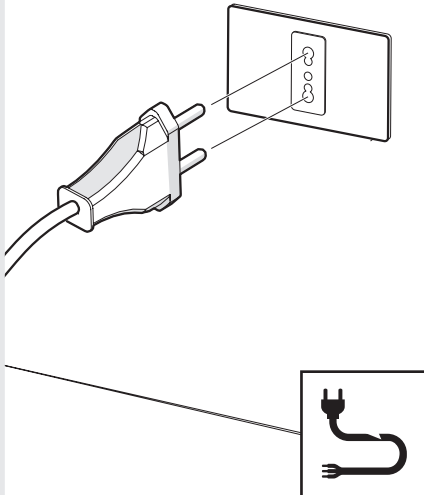

7

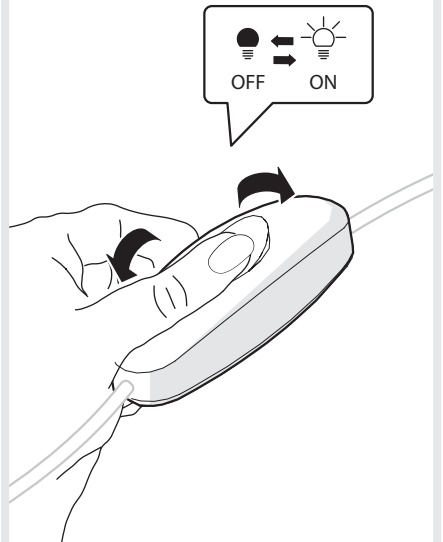

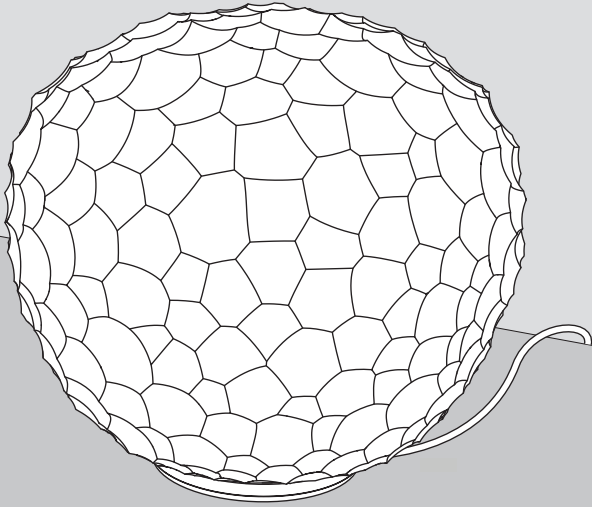



i



1

2

3

4

5

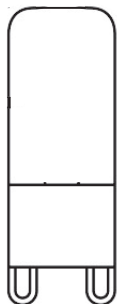

MAX 33W - G9

Halo: HSGST - 450 lm

LED: DRT - 300 lm

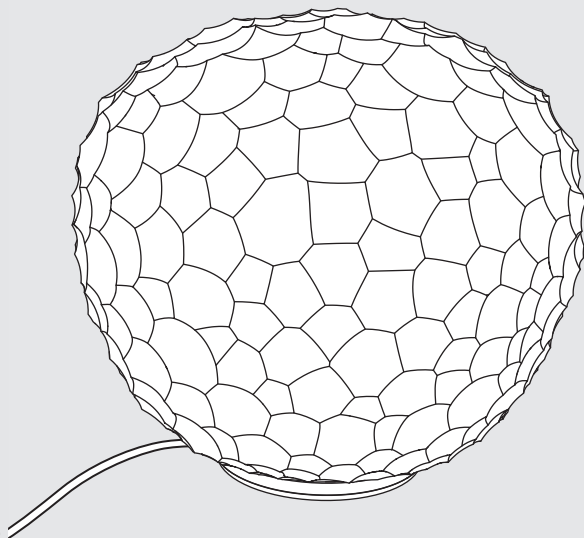

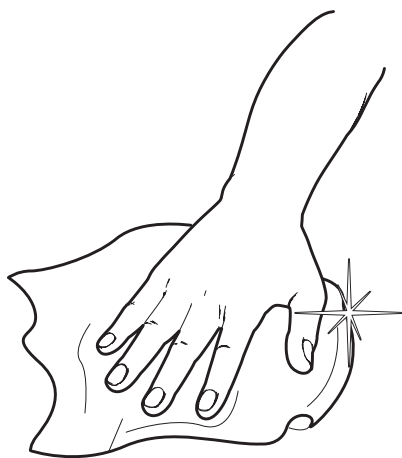

Artemide®



Artemide

via Bergamo, 18
20010 Pregnana M.se (MI)
ITALIA

tel. +39 02 935 181
fax +39 02 935 90 254
fax +39 02 935 90 496

www.artemide.com

VAT IT00846890150

cod. Y513000568