

Artemide®

Meteorite 15

design
Pio & Tito Toso

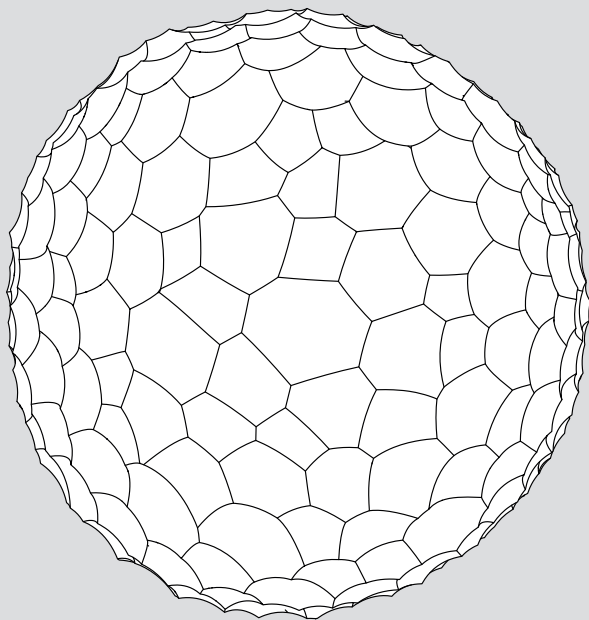



i

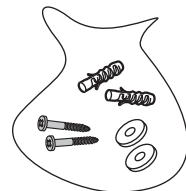
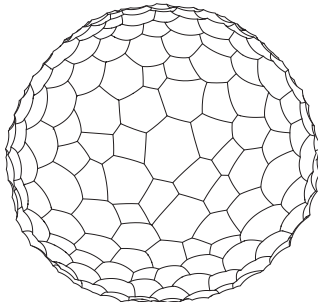
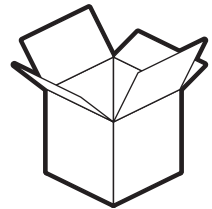
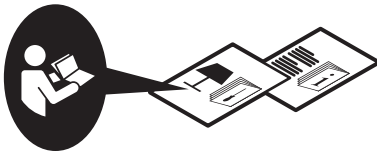
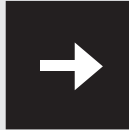
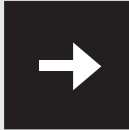
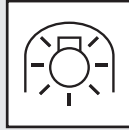
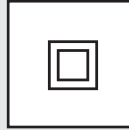

1

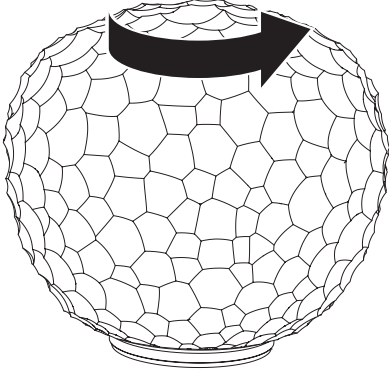

2

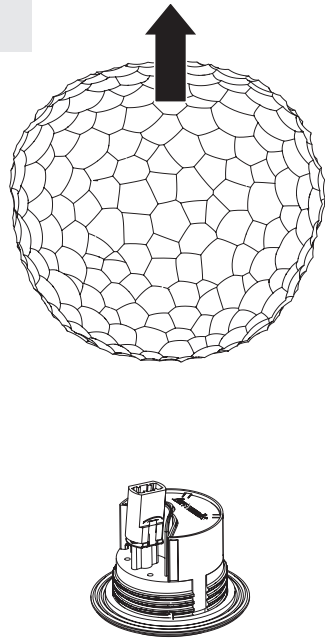

3

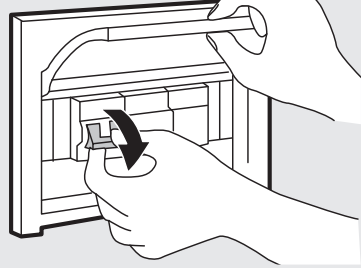
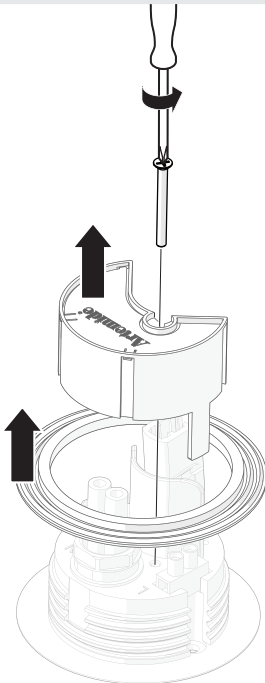

4



5

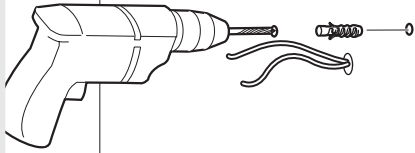

6

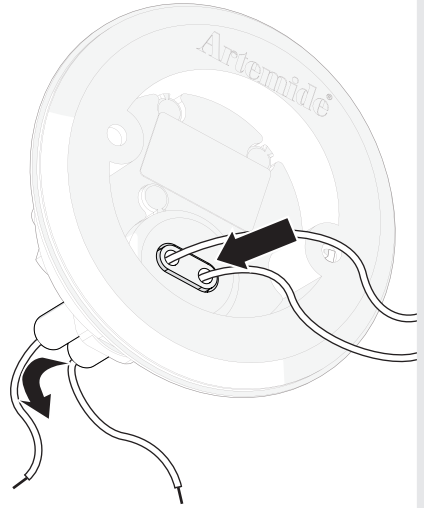

7

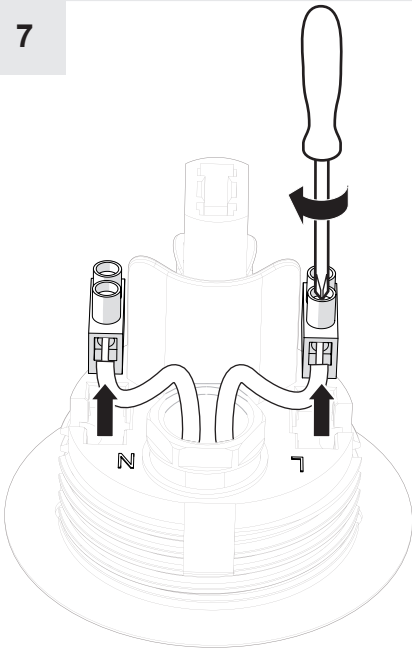

8

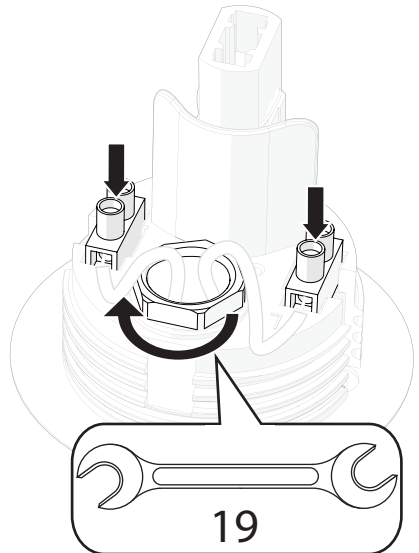

9

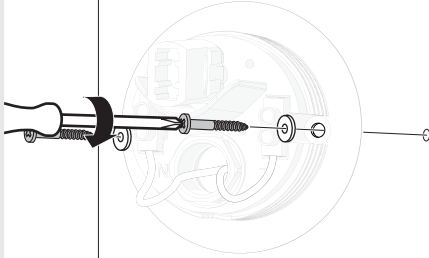

10

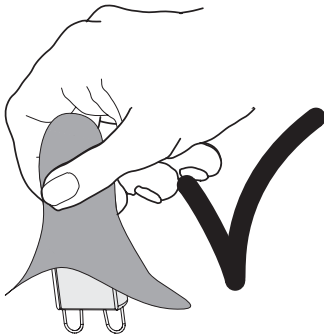
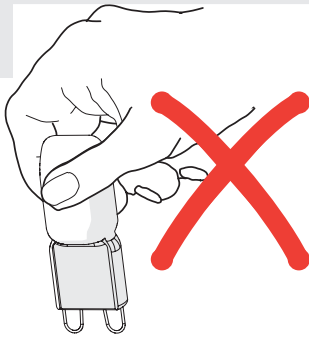
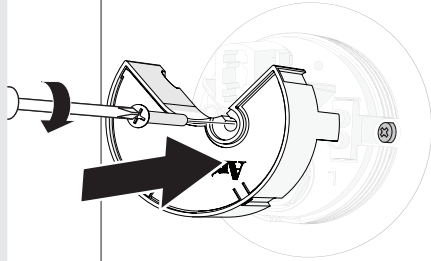

11

G9 - MAX 48W

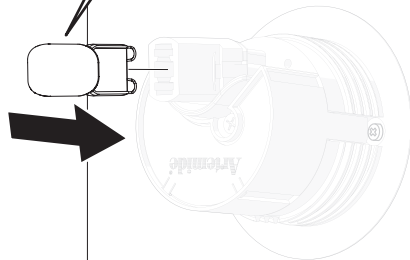

12

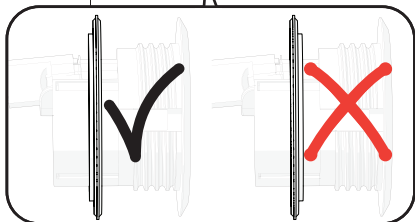
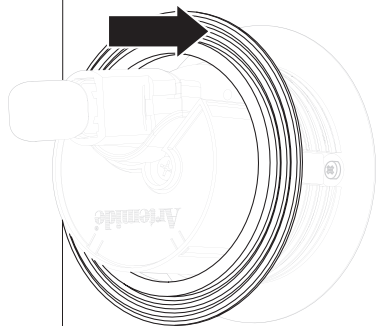

13

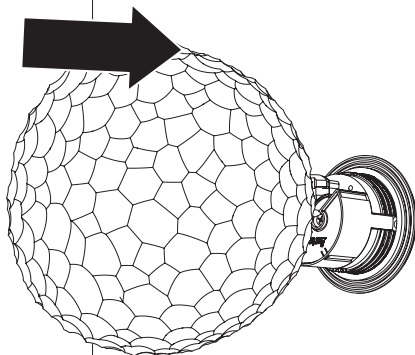

14

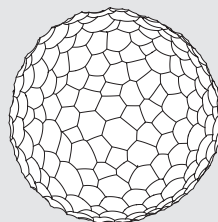
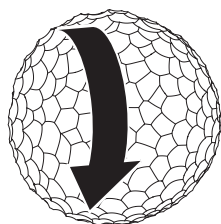

i



1

2

11

13

14

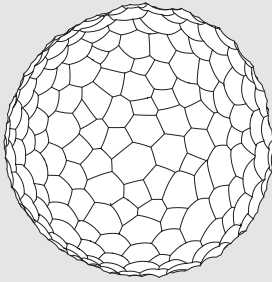

MAX 48W - G9

Halo: HSGST - 750 lm

LED: DRT - 300 lm

i



1

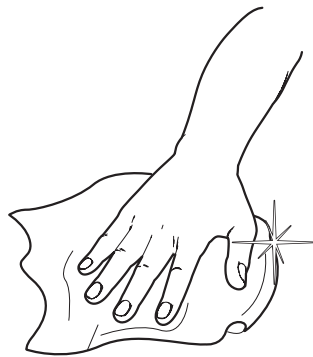

Artemide®

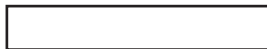

Artemide

via Bergamo, 18
20010 Pregnana M.se (MI)
ITALIA

tel. +39 02 935 181
fax +39 02 935 90 254
fax +39 02 935 90 496

www.artemide.com

VAT IT00846890150

cod. Y513000574