

Artemide®

Empatia 16

design

C. de Bevilacqua - P. di Arianello

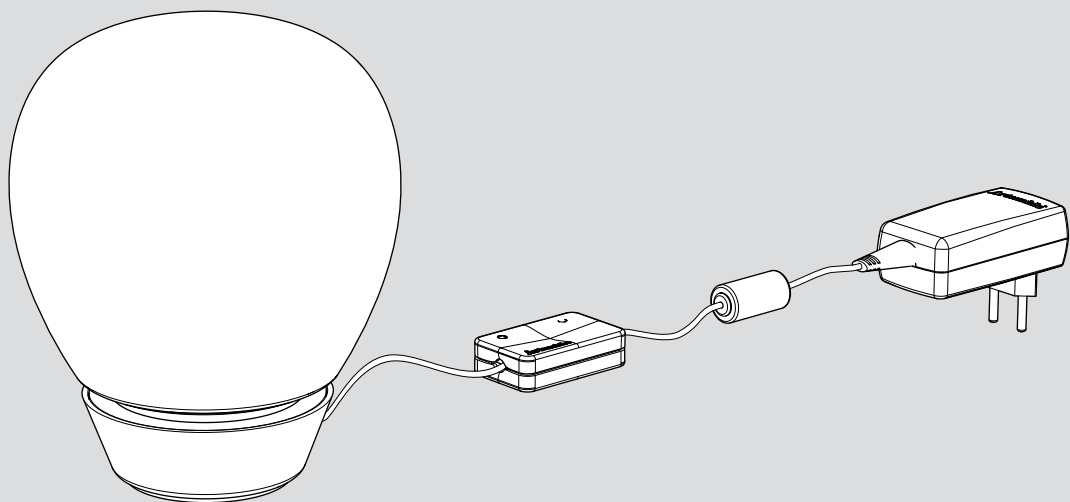



i

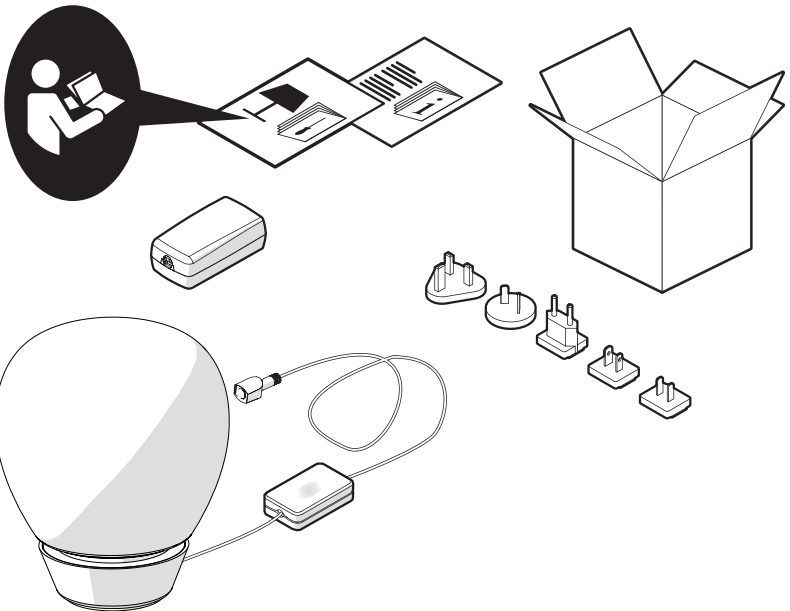
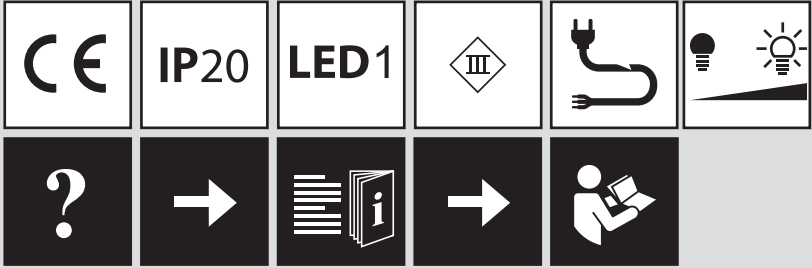

1

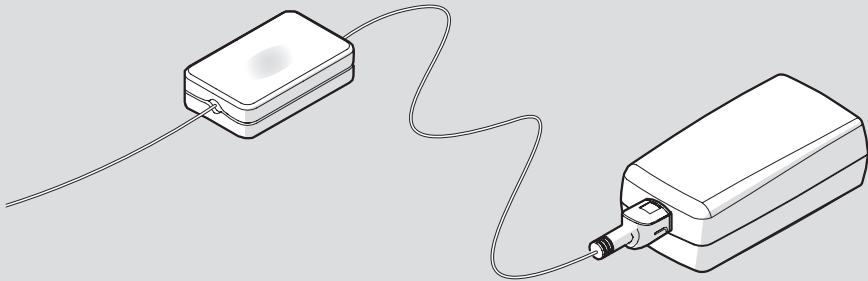
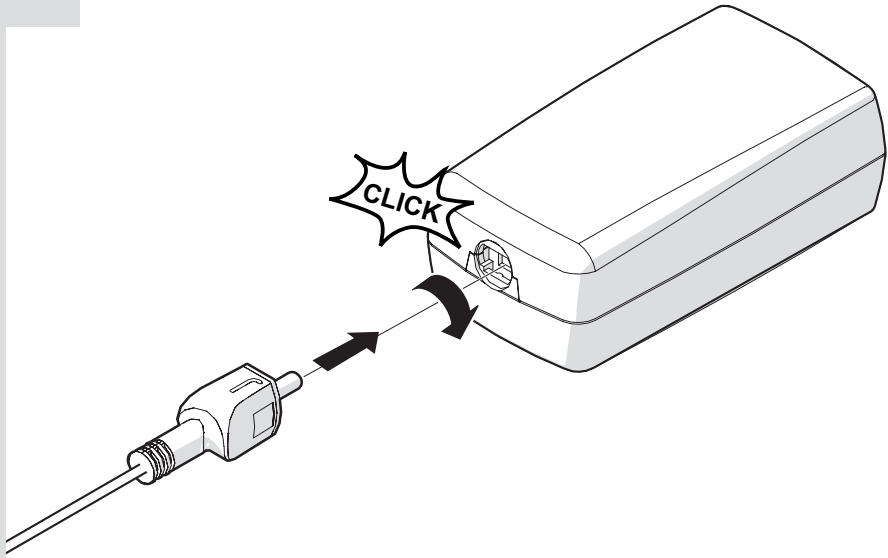



i

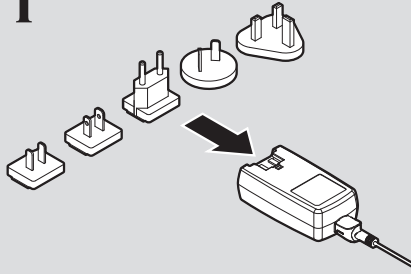

1

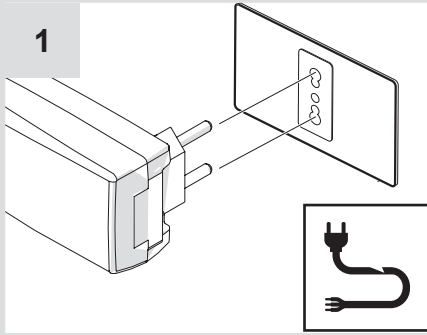

2

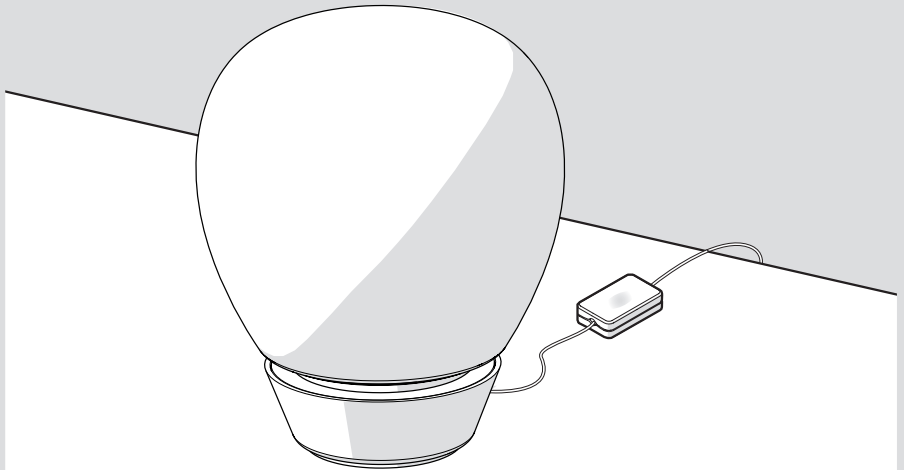
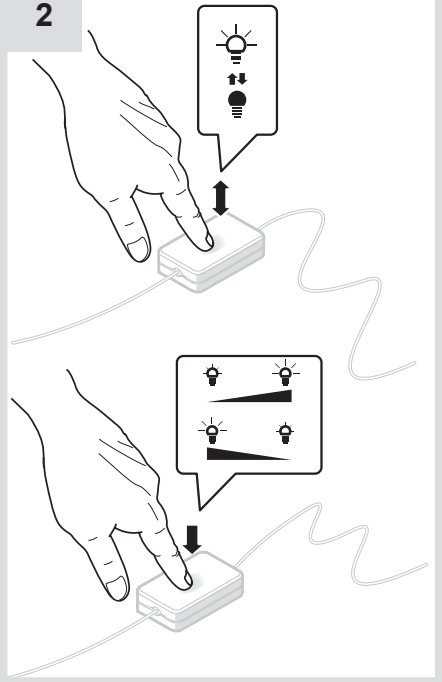

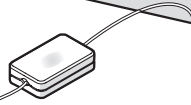
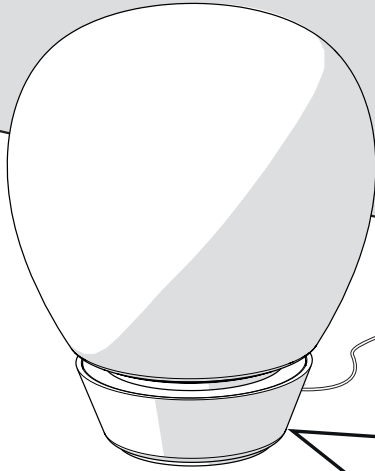

45°C

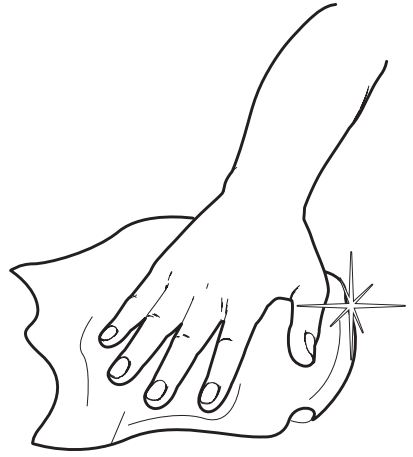
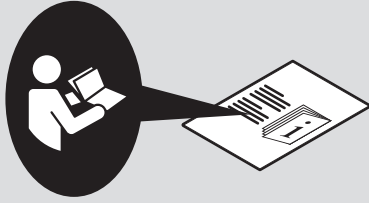

Artemide®



Artemide

via Bergamo, 18
20010 Pregnana M.se (MI)
ITALIA

tel. +39 02 935 181
fax +39 02 935 90 254
fax +39 02 935 90 496

www.artemide.com

VAT IT00846890150

cod. Y513000181B