

# Artemide®

## Castore

design  
M. De Lucchi / H. Ubbens

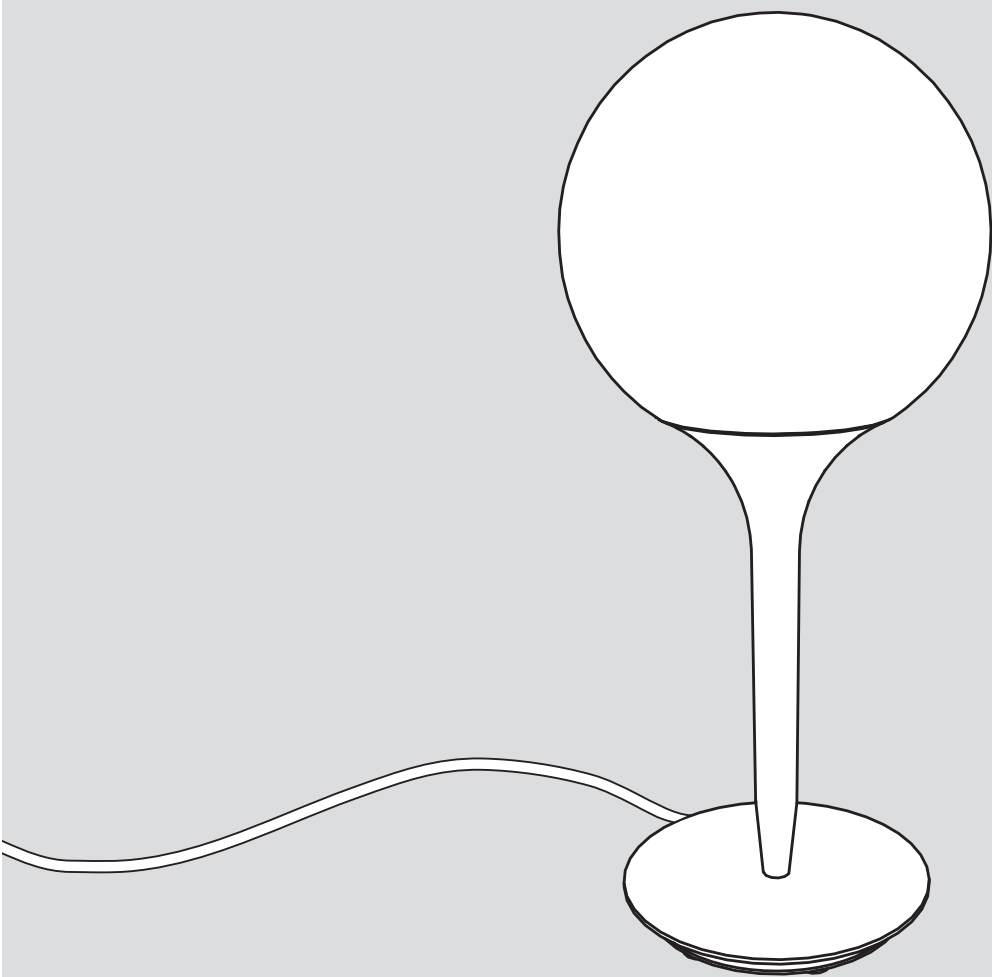



i

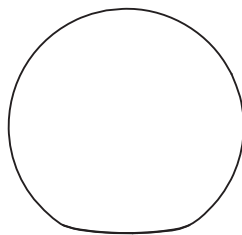
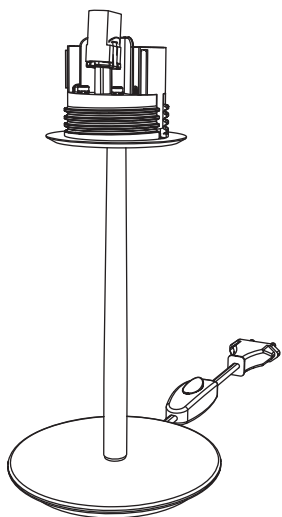
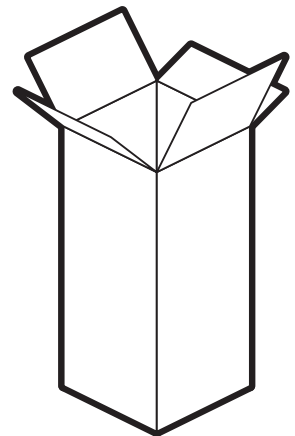
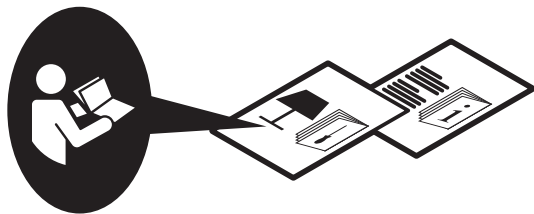
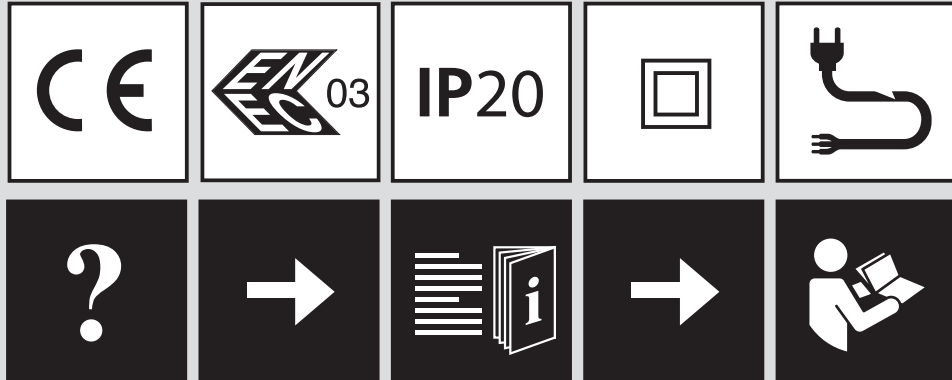

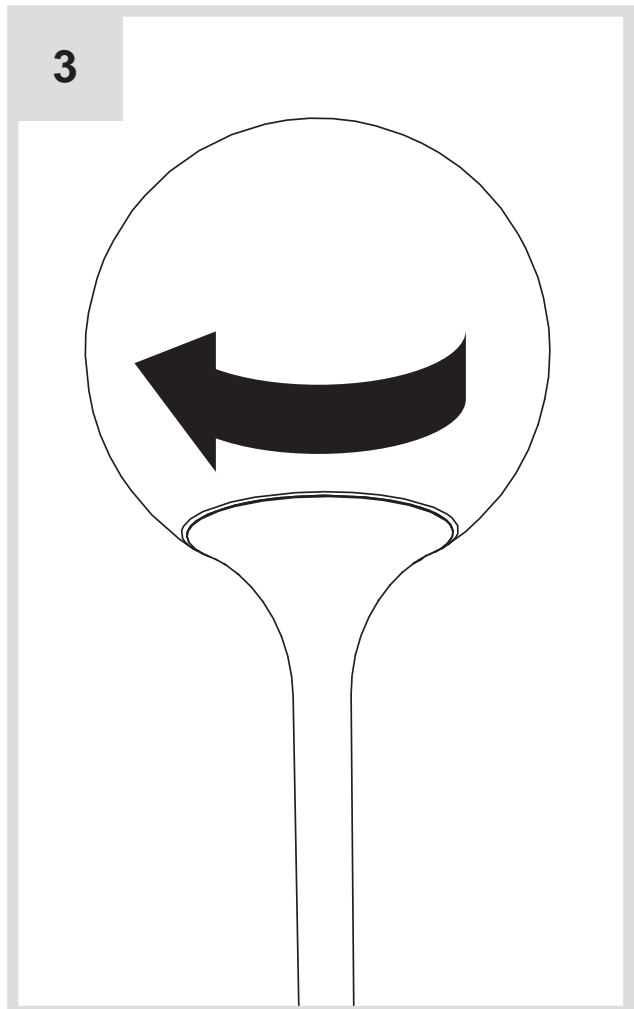
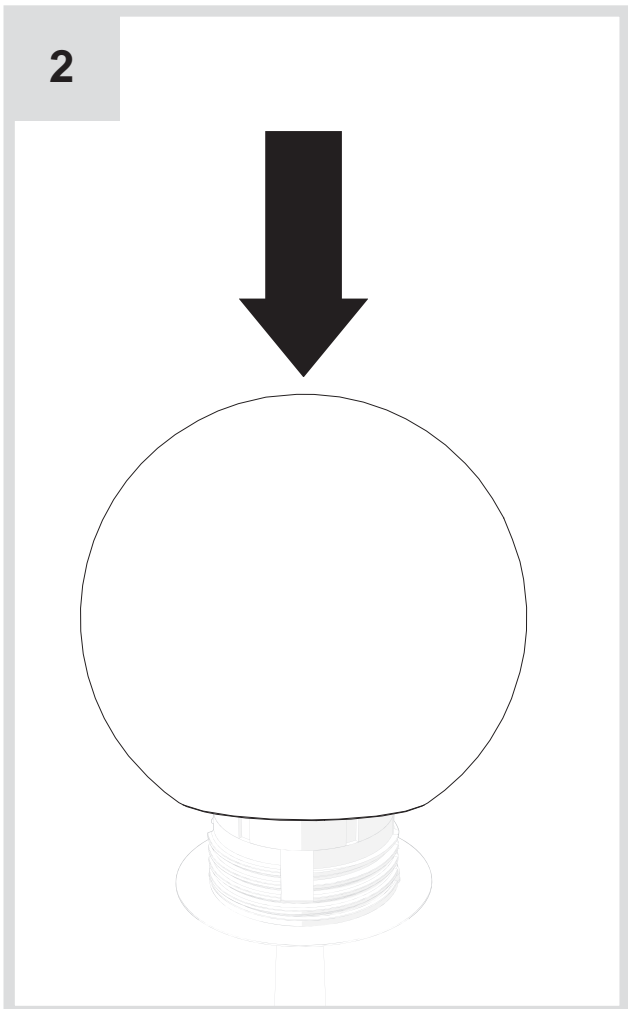
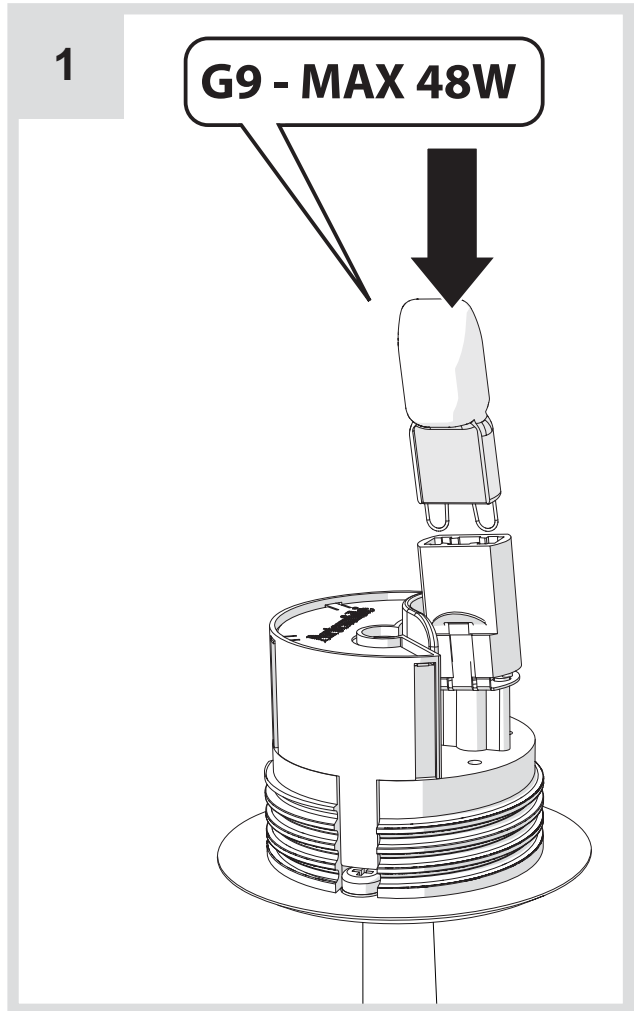
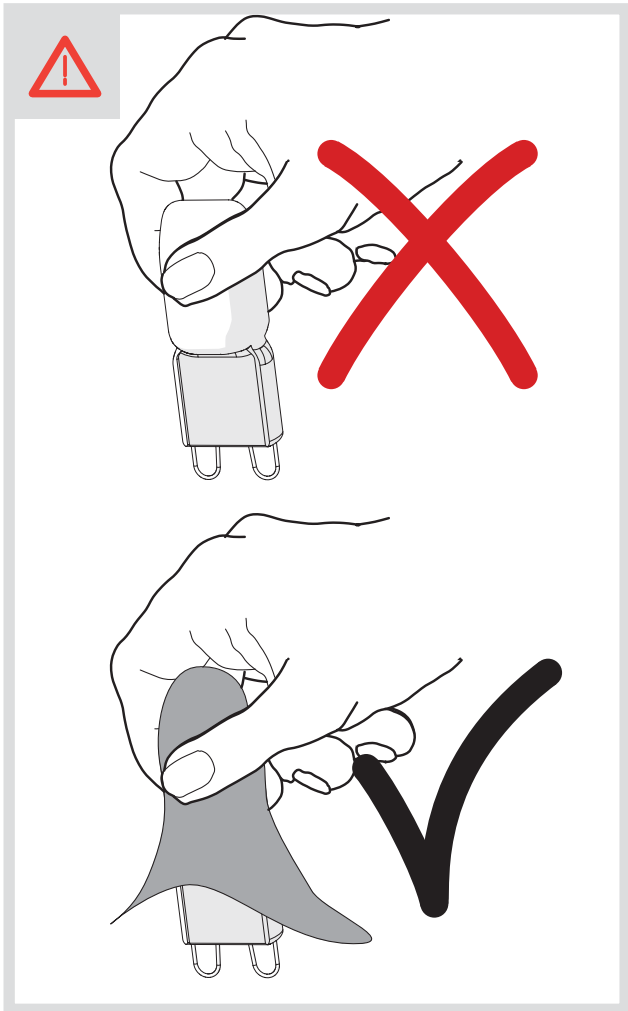



6

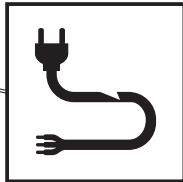
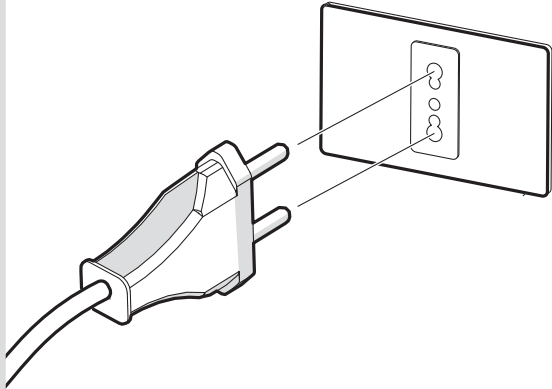

7

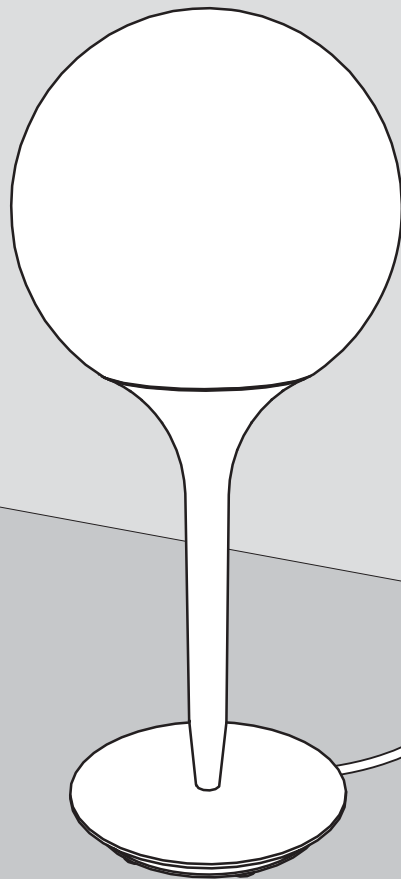
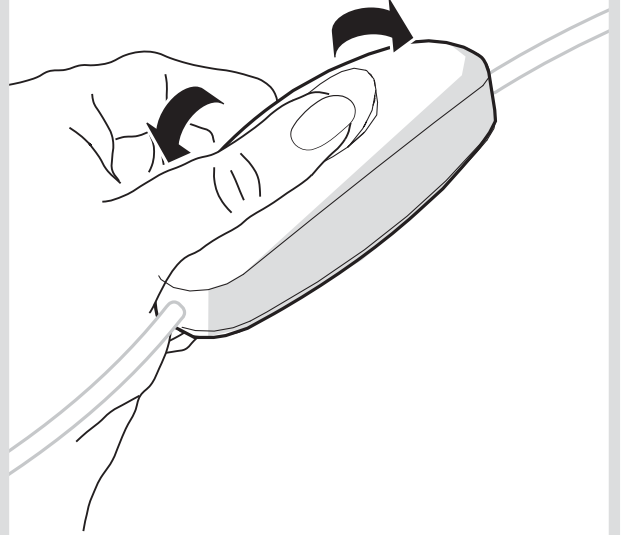
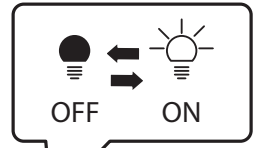



**i**

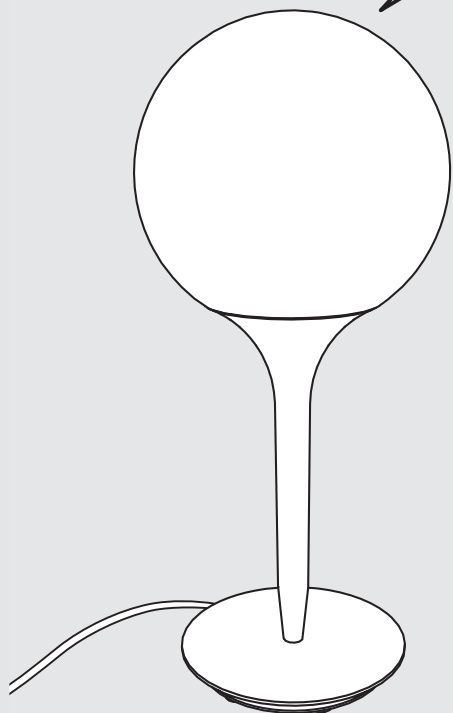

	<b>MAX 48W - G9</b>
	Halo: HSGST - 750 lm
	LED: DRT - 300 lm

**1**

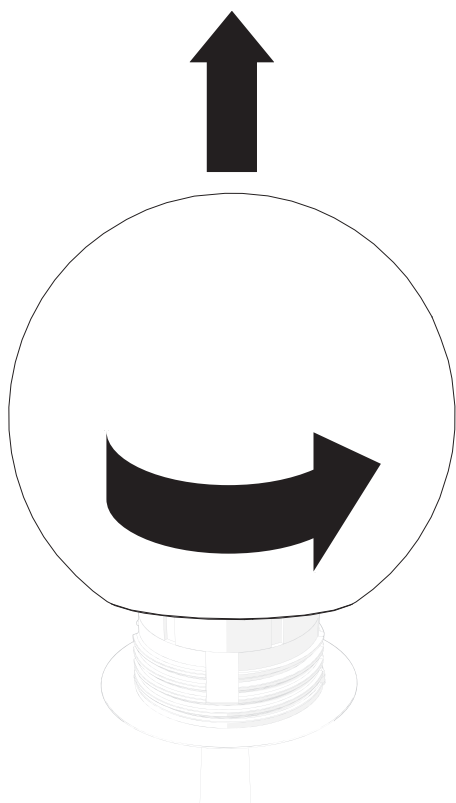



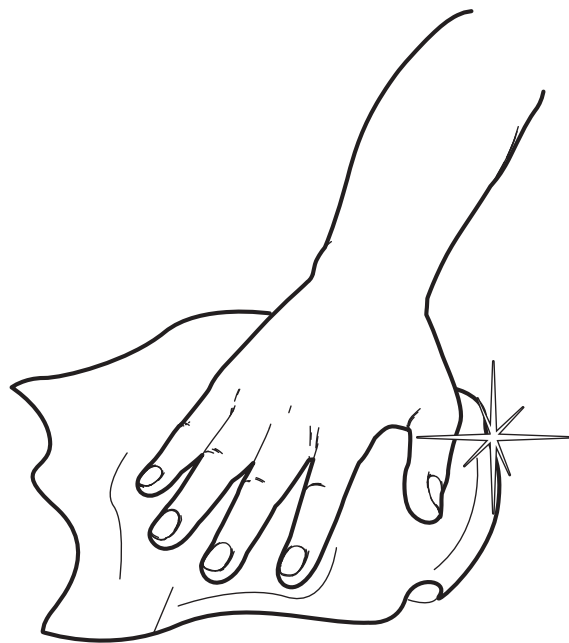
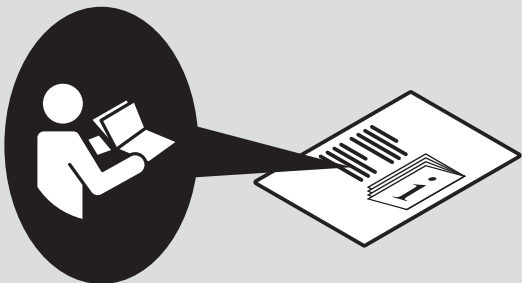

**Artemide®**



## **Artemide**

via Bergamo, 18  
20010 Pregnana M.se (MI)  
ITALIA

tel. +39 02 935 181  
fax +39 02 935 90 254  
fax +39 02 935 90 496

[www.artemide.com](http://www.artemide.com)

VAT IT00846890150

cod. Y513000630