

Vector Track 40 10W 28° 4000K Undimmable Brushed Copper



IP20 

DESIGN BY

Carlotta de Bevilacqua

DESCRIPTION

Three sizes with three different beam angles each (spot, flood, wide flood) obtained by means of refractive or hybrid optical units. Vector 55 track DALI zoom optic (22°-32°). Junction arm integrated in the spotlight's body to keep the barycentre aligned with the track and prevent any imbalance in possible suspension versions of the track. The junction allows 360° rotation and 90° tilting for maximum emission adjustment freedom. Vector 95 available only in track version. Version with compact 4-conductor (3p+n) adapter with hidden LED driver and not-dimmable phase selector.

TECHNICAL DRAWINGS

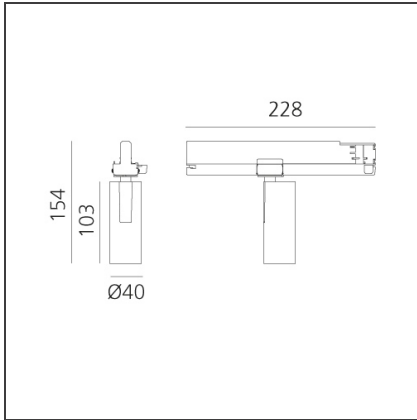

FEATURES

Article Code:	AN05318	Series:	Indoor, 2018 Artemide Collection
Colour:	Brushed Copper		
Installation:	Projector, Track		
Environment:	Indoor		

DIMENSIONS

Height:	cm 15.4
Base Length:	cm 22.8
Inclination:	-90+90
Rotation:	cm 360

INCLUDED SOURCES

Category:	LED	Color temperature (K):	4000K
Number:	1	Color Tolerance:	MacAdam 3SDCM
Watt:	10W	Service Life:	L70 (6K) 50000h
Type:	0		
Class:	A		

LUMINAIRE

Watt:	10W	Delivered lumens output (lm):	566lm
		CCT:	4000K
		Efficiency:	63%
		Efficacy:	56.65lm/W
		CRI:	90

Notes

220/240Vac 50/60Hz Electronic ballast included.

ACCESSORIES

Accessories holder
- Vector 40
AP90100



Lens for elliptical
emission - Vector
40
AP90200



Soft filter - Vector
40
AP90300



Anti-dazzle louvre
- Vector 40
AP90400