

## Vector Semirecessed 55 - 17,5W 22° 4000K Black

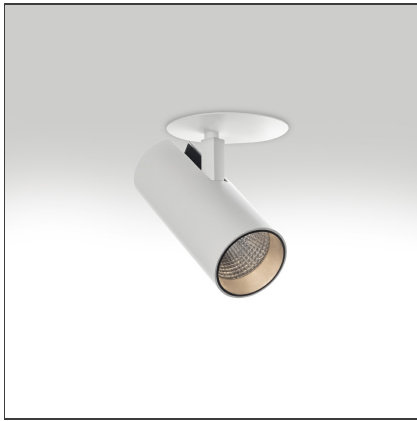

IP20 

### DESIGN BY

Carlotta de Bevilacqua

### DESCRIPTION

Two sizes with three different beam angles each (spot, flood, wide flood) obtained by means of refractive or hybrid optical units. The junction allows 360° rotation and 90° tilting for maximum emission adjustment freedom. Vector 40 and 55 available version: semirecessed.

### TECHNICAL DRAWINGS

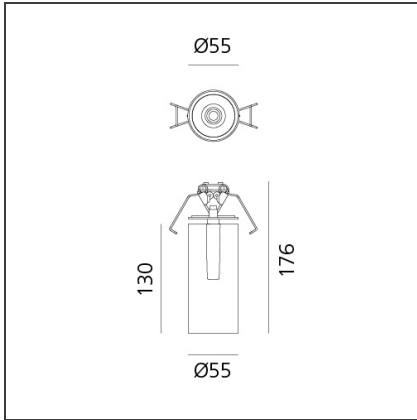

### FEATURES

<b>Article Code:</b>	AP66204	<b>Material:</b>	Alluminium body
<b>Colour:</b>	Black	<b>Series:</b>	Indoor, 2018
<b>Installation:</b>	Projector, Recessed		Artemide Collection
<b>Environment:</b>	Indoor		

### DIMENSIONS

<b>Height:</b>	cm 19	<b>Cutout diameter:</b>	cm 5
<b>Base Diameter:</b>	cm 10.8		
<b>Inclination:</b>	-90+90		
<b>Rotation:</b>	cm 360		

### INCLUDED SOURCES

<b>Category:</b>	LED	<b>Color temperature (K):</b>	4000K
<b>Number:</b>	1	<b>Color Tolerance:</b>	MacAdam 3SDCM
<b>Watt:</b>	17,5W	<b>CRI:</b>	90
<b>Type:</b>	0	<b>Service Life:</b>	L70 (6K) 50000h

### LUMINAIRE

<b>Watt:</b>	21W	<b>Delivered lumens output (lm):</b>	1489lm
		<b>CCT:</b>	4000K
		<b>Efficiency:</b>	62%
		<b>Efficacy:</b>	70.89lm/W
		<b>CRI:</b>	90

### Notes

Driver 700/600mA SELV supplied separately. Depending on the driver, the product can be dimmable DALI or undimmable.

**ACCESSORIES**

Driver 15-32W  
500-700mA - 220-  
24Vac -  
Undimmable -  
146,5x43,5x22 mm  
(LxWxH)  
dv1030



Driver 11-25W  
500-700mA - 220-  
24Vac - Dimmable  
DALI -  
164x38x24,5 mm  
(LxWxH)  
dv1031