

Vector Semirecessed 40 - 8W 20° 3000K White



IP20 

DESIGN BY

Carlotta de Bevilacqua

DESCRIPTION

Two sizes with three different beam angles each (spot, flood, wide flood) obtained by means of refractive or hybrid optical units. The junction allows 360° rotation and 90° tilting for maximum emission adjustment freedom. Vector 40 and 55 available version: semirecessed.

TECHNICAL DRAWINGS

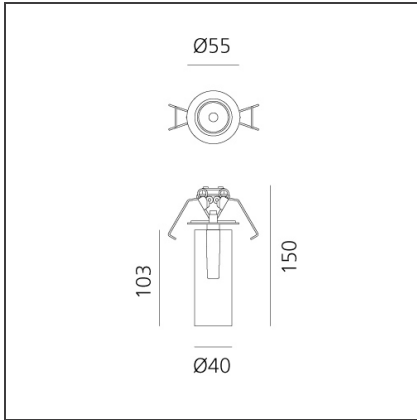

FEATURES

Article Code:	AP60201	Material:	Alluminium body
Colour:	White	Series:	Indoor, 2018
Installation:	Projector, Recessed		Artemide Collection
Environment:	Indoor		

DIMENSIONS

Height:	cm 16.3	Cutout diameter:	cm 5
Base Diameter:	cm 10.8		
Inclination:	-90+90		
Rotation:	cm 360		

INCLUDED SOURCES

Category:	LED	Color temperature (K):	3000K
Number:	1	Color Tolerance:	MacAdam 3SDCM
Watt:	8W	CRI:	90
Type:	0	Service Life:	L70 (6K) 50000h

LUMINAIRE

Watt:	8W	Delivered lumens output (lm):	584lm
		CCT:	3000K
		Efficiency:	69%
		Efficacy:	73.03lm/W
		CRI:	90

Notes

Driver 700/600mA SELV supplied separately. Depending on the driver, the product can be dimmable DALI or undimmable.

ACCESSORIES

Driver 15-32W
500-700mA - 220-
24Vac -
Undimmable -
146,5x43,5x22 mm
(LxWxH)
dv1030



Driver 11-25W
500-700mA - 220-
24Vac - Dimmable
DALI -
164x38x24,5 mm
(LxWxH)
dv1031