

## Vector Recessed 40 - 8W 28° 2700K Black

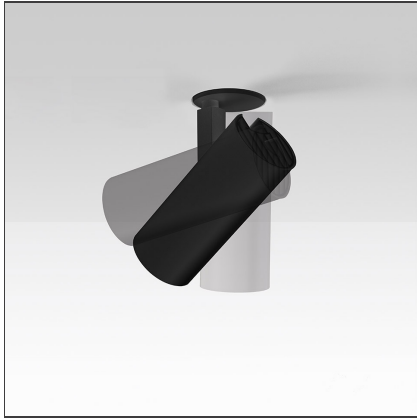

IP20 

### DESIGN BY

Carlotta de Bevilacqua

### DESCRIPTION

Two sizes with three different beam angles each (spot, flood, wide flood) obtained by means of refractive or hybrid optical units. The junction allows 360° rotation and 90° tilting for maximum emission adjustment freedom. Vector 40 and 55 available version: recessed trim or trimless.

### TECHNICAL DRAWINGS

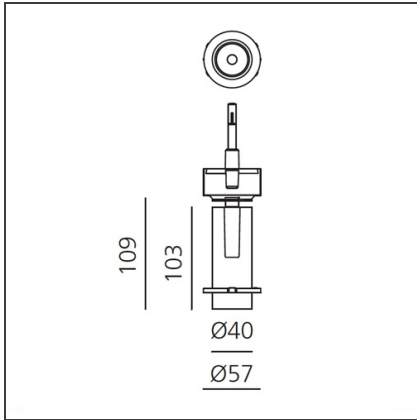

### FEATURES

<b>Article Code:</b>	AP52304	<b>Material:</b>	Alluminium body
<b>Colour:</b>	Black	<b>Series:</b>	Indoor, 2018
<b>Installation:</b>	Projector, Recessed		Artemide Collection
<b>Environment:</b>	Indoor		

### DIMENSIONS

<b>Height:</b>	cm 10.9	<b>Cutout diameter:</b>	cm 8.6
<b>Inclination:</b>	-90+90		
<b>Rotation:</b>	cm 360		

### INCLUDED SOURCES

<b>Category:</b>	LED	<b>Color temperature (K):</b>	2700K
<b>Number:</b>	1	<b>Color Tolerance:</b>	MacAdam 3SDCM
<b>Watt:</b>	8W	<b>CRI:</b>	90
<b>Type:</b>	0	<b>Service Life:</b>	L70 (6K) 50000h

### LUMINAIRE

<b>Watt:</b>	8W	<b>Delivered lumens output (lm):</b>	491lm
		<b>CCT:</b>	2700K
		<b>Efficiency:</b>	63%
		<b>Efficacy:</b>	61.37lm/W
		<b>CRI:</b>	90

### Notes

Trimless recessed structure not included, to be ordered separately. Driver 700/500mA SELV supplied separately. Depending on the driver, the product can be dimmable DALI or undimmable.

**ACCESSORIES**

Driver 15-32W  
500-700mA - 220-  
24Vac -  
Undimmable -  
146,5x43,5x22 mm  
(LxWxH)  
dv1030



Driver 11-25W  
500-700mA - 220-  
24Vac - Dimmable  
DALI -  
164x38x24,5 mm  
(LxWxH)  
dv1031



Vector 40 -  
Optional Trim  
Frame Ø 108 -  
White  
Ap59001



Vector 40 -  
Optional Trim  
Frame Ø 108 -  
Black  
Ap59004



Vector 40 -  
Trimless recessed  
structure  
AP50000