

Vector Magnetic 40 - 10W 20° 4000K DALI Brushed copper



IP20   Dimmerable: +  -

DESIGN BY

Carlotta de Bevilacqua

DESCRIPTION

Two sizes with three different beam angles each (spot, flood, wide flood) obtained by means of refractive or hybrid optical units. Junction arm integrated in the spotlight's body to keep the barycentre aligned with the track and prevent any imbalance in possible suspension versions of the track. The junction allows 360° rotation and 90° tilting for maximum emission adjustment freedom.

TECHNICAL DRAWINGS

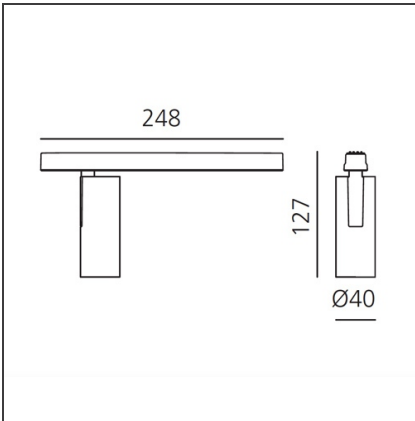

FEATURES

Article Code:	AP05218	Series:	Indoor, 2018
Colour:	Brushed copper		Artemide Collection
Installation:	Projector, Track		
Environment:	Indoor		

DIMENSIONS

Height:	cm 12.7
Base Length:	cm 24.8
Inclination:	-90+90
Rotation:	cm 360

INCLUDED SOURCES

Category:	LED	Color temperature (K):	4000K
Number:	1	Color Tolerance:	MacAdam 3SDCM
Watt:	10W	Service Life:	L70 (6K) 50000h
Type:	0		
Class:	A		

LUMINAIRE

Watt:	10W	Delivered lumens output (lm):	626lm
		CCT:	4000K
		Efficiency:	69%
		Efficacy:	62.60lm/W
		CRI:	90
		Dimmable Typology:	Dali

Notes

For operation use only Artemide Power Supply kit.

ACCESSORIES

Accessories holder
- Vector 40
AP90100



Lens for elliptical
emission - Vector
40
AP90200



Soft filter - Vector
40
AP90300



Anti-dazzle louvre
- Vector 40
AP90400