

Tagora Suspension 270 - LED 32° - 3000K - Black/Green



IP20   Dimmerable: 

DESIGN BY

S./R. Cornelissen

DESCRIPTION

Series of suspended luminaires available in 4 diameters (80 mm, 270 mm, 570 mm, 970 mm), using high-output LEDs, Retrofit LEDs. □Aluminium body available in different two-coloured versions: beige/white, grey/white, black/orange, black/vert and black/blue. □Steel suspension cables allowing quick adjustment, 2 metre length. □Tagora 80 and 270 offer a high-output spot light with aluminium optics. □Tagora 270 uses a proprietary system based on a hybrid combined lens and reflector optic. This system helps to create defined narrow beams using high-powered LED modules of large dimensions. □Tagora 570 and 970 come with a PMMA diffuser, offering a comfortable diffused light. LED versions use high-output sources. □Integrated electronic power supply, dimmable or non-dimmable options, depending on the version. □Compliant with standard EN60598-1 and other specific standards.

TECHNICAL DRAWINGS

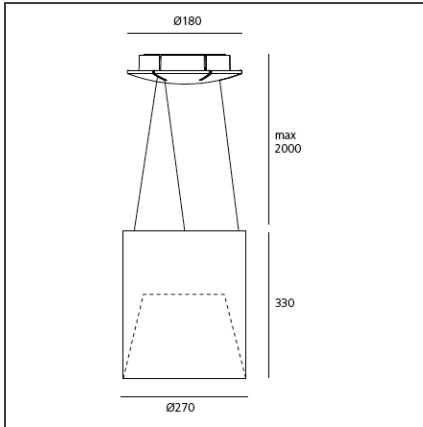

FEATURES

Article Code:	M249841	Material:	Aluminium
Colour:	Black/Green	Series:	Indoor
Installation:	Suspension		

DIMENSIONS

Height:	cm 33	Cutout shape:	Rounded
Weight:	kg 4.7	Glow Wire Test:	960
Base Diameter:	cm 18		
Max Height from ceiling:	cm 200		

INCLUDED SOURCES

Category:	LED	Color temperature (K):	3000K
Number:	1	Color Tolerance:	MacAdam 1SDCM
Watt:	34W	CRI:	90
Type:	0	Service Life:	L70 (6K) 50000h
Class:	A		

LUMINAIRE

Power Supply:	220/240Vac 50/60Hz electronic ballast included	Delivered lumens output (lm):	1636lm
Watt:	34W	CCT:	3000K
Voltage:	220V-240V	Efficiency:	43%
		Efficacy:	40.97lm/W
		CRI:	90
		Dimmable Typology:	Dali