

# Tagora Ceiling 570 - LED 4000K - Dali SwitchDim - Beige/White



IP40 Dimmerable: + -

## DESIGN BY

S./R. Cornelissen

## DESCRIPTION

Series of ceiling mounted luminaires available in 4 diameters (80 mm, 270 mm, 570 mm, 970 mm), using high-output LEDs, Retrofit LEDs. □Aluminium body available in different two-coloured versions: beige/white, grey/white, black/orange, black/vert and black/blue. □Tagora 80 and 270 offer a high-output spot light with aluminium optics. □Tagora 270 uses a proprietary system based□on a hybrid combined lens and reflector optic. This system helps to create defined narrow beams using high-powered LED modules of large dimensions. □Tagora 570 and 970 come with a PMMA diffuser, offering a comfortable diffused light. LED versions use high-output sources. □Integrated electronic power supply, dimmable or non-dimmable options, depending on the version. Only ceiling mounted installation allowed.□Compliant with standard EN60598-1 and other specific standards.

## TECHNICAL DRAWINGS

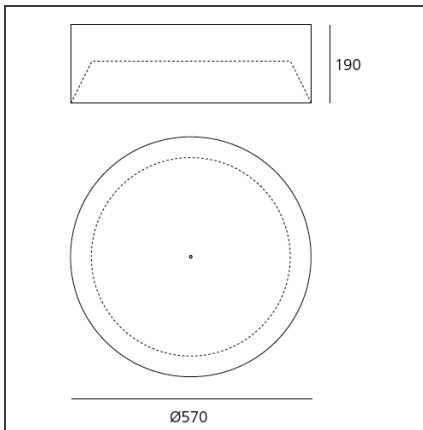

## FEATURES

<b>Article Code:</b>	M248321	<b>Material:</b>	Aluminium
<b>Colour:</b>	Beige/White	<b>Series:</b>	Indoor
<b>Installation:</b>	Ceiling		

## DIMENSIONS

<b>Height:</b>	cm 19	<b>Cutout shape:</b>	Rounded
<b>Weight:</b>	kg 4.9	<b>Glow Wire Test:</b>	650

## INCLUDED SOURCES

<b>Category:</b>	LED	<b>Color temperature (K):</b>	3000K
<b>Number:</b>	1	<b>Color Tolerance:</b>	MacAdam 3SDCM
<b>Watt:</b>	58W	<b>CRI:</b>	80
<b>Type:</b>	0	<b>Service Life:</b>	L70 (6K) 50000h
<b>Class:</b>	A		

## LUMINAIRE

<b>Power Supply:</b>	220/240Vac 50/60Hz electronic ballast included	<b>Delivered lumens output (lm):</b>	3820lm
<b>Watt:</b>	58W	<b>CCT:</b>	4000K
<b>Voltage:</b>	220V-240V	<b>Efficiency:</b>	43%
		<b>Efficacy:</b>	63.67lm/W
		<b>CRI:</b>	80
		<b>Dimmable Typology:</b>	Dali